

FORM 1 WORK

CHAPTER ONE

INTRODUCTION TO BIOLOGY

PAST KCSE QUESTIONS ON THE TOPIC

1. Write three major differences between plants and animals.
2. List the use of the energy obtained from the process of respiration.
3. State three characteristic similar in plants and animals.

(Section A)

4. Motor vehicles move, use energy and produce carbon dioxide and water. Similar characteristics occur in living organisms yet motor vehicles are not classified as living. List other characteristics of living things that do NOT occur in motor vehicles.

CHAPTER TWO

CLASSIFICATION I

INTRODUCTION

PAST KCSE QUESTIONS ON THE TOPIC

1.
 - a) What is meant by the term binomial nomenclature? (1mk)
 - b) Give two reasons why classification is important (2mks)
2. Explain the following terms; (3mks)
 - a) Classification
 - b) Taxonomy
 - c) Binomial nomenclature
3.
 - a) State three characteristics of Monera that are not found in other kingdoms (3mks)
 - b) Name the class to which a termite belongs (1mk)
4. Ascaris lumbricoides is an example of an endoparasite. The name Ascaris refer to
5. Blackjack (Bidens pilosa) belongs to the family compositae. What does pilosa stand for? (1mk)
6. Define the term species. (1mk)
7. Distinguish between Taxonomy and taxon. (1mk)

CHAPTER THREE

THE CELL

PAST KCSE QUESTION ON THE TOPIC

1. Which organelle would be abundant in?

Skeletal muscle cell _____

Palisade cell _____

2. State the functions of the following organelles.

Lysosomes _____

Golgi apparatus _____

3. State the functions of the following organelles;

Goigi apparatus _____

Ribosomes cell _____

4. Name the organelles that perform each of the following functions in a cell.

Protein synthesis _____

Transport cell secretions _____

5. The diagram below represents a cell.

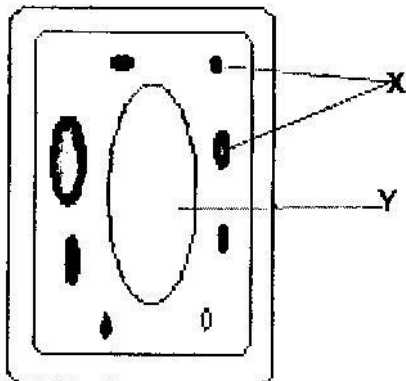

a) Name the parts labeled x and y

X _____

Y _____

b) Suggest why the structures labeled x would be more on one side than the other side.

6.

a) State the function of cristae in mitochondria (1mk)

b) The diagram below represents a cell organelle

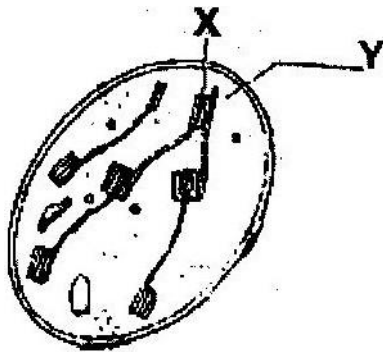

(i) Name the part labeled Y (1mk)

(ii) State the function of the part labeled X (2 mks)

7.

- a) What is the formula for calculating linear magnification of a specimen when using a hand lens? (1mk)
- b) Give a reason why staining is necessary when preparing specimens for observation under the microscope. (1mk)
8. State three functions of Golgi apparatus. (3mks)
9. Name two structures found in plant cell but are absent in animals cell.
10. Write the role of the following parts of a microscope
- i) Nerve cell
 - ii) Palisade cell
 - iii) Root hair cell
 - iv) Red blood cell
11. The diameter field of view of a light microscopic is 3.5mm. Plant cells lying of the diameter are 10. Determine the size of one cell microns (1mm = 1000 μ m)
12. Define the following
- i) Tissue
 - ii) Organ
 - iii) Organ system

CHAPTER FOUR

CELL PHYSIOLOGY

PAST KCSE QUESTIONS ON THE TOPIC

1. The table below shows the concentration of some ions in pond water and in the cells sap of an aquatic plant growing in the pond.

Ions	Concentration in pond water (parts per million)	Concentration in cell sap (parts per million)
Sodium	50	30
Potassium	2	150
Calcium	1.5	1
Chloride	180	200

- a) Name the processes by which the following ions could have been taken up by this plant. (2mks)
- i) Sodium ions
 - ii) Potassium ions
- b) For each processes named in (a) (i) and (ii) above, state one condition necessary for the process to take place. (2mks)
2. Explain how water in the soil enters the root hairs of a plant. (4mks)
3. Explain how drooping of leaves on a hot sunny day is advantageous to a plant. (2mks)

4. a) What is diffusion? (2mks)
- b) How do the following factors affect the rate of diffusion?
- i) Diffusion gradient (1mk)
- ii) Surface area to volume ratio (1mk)
- iii) Temperature (1mk)
- c) Outline 3 roles of active transport in the human body (2mks)
5. State the importance of osmosis in plants (3mks)
6. An experiment was set up as shown in the diagram below.

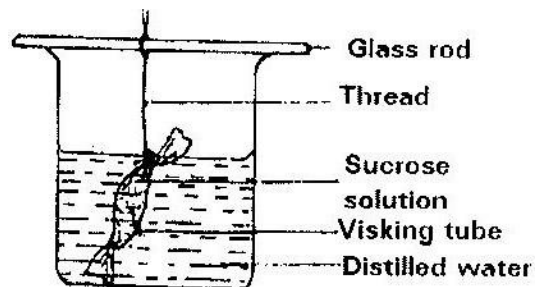

- The set up was left for 30 minutes.
- a) State the expected results. (1mk)
- b) Explain your answer in (a) above. (3mks)
7. Explain why plant cells do not burst when immersed in distilled water. (2mks)
8. Distinguish between diffusion and osmosis. (2mks)
9. Define the following terms in relation to a cell
- a) Isotonic solution

- b) Hypotonic solution
 - c) Hypertonic solution (3mks)
10. Addition of large amounts of salt to soil in which plants are growing kills the plants. Explain (6mks)
11. Explain why
- a) Red blood cells burst when placed in distilled water while plant cells remain intact.
 - b) Fresh water protozoa like amoeba do not burst when placed in distilled water. (2mks)

CHAPTER 5

NUTRITION IN PLANTS

PAST KCSE QUESTIONS ON THE TOPIC

1. An experiment was carried out to investigate the rate of reaction shown below.

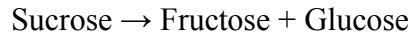

For the products; fructose and glucose to be formed, it was found that substance K was to be added and the temperature maintained at 37°C. When another substance L was added, the reaction slowed down and eventually stopped.

- a) Suggest the identity of substances K and L. (2mks)

K _____

L _____

- b) Other than temperature state three ways by which the rate of reaction could be increased. (3mks)

- c) Explain how substance L slowed down the reaction. (1mk)

2. State the role of light in the process of photosynthesis. (2mks)

Name one product of dark reaction in Photosynthesis (1mk)

3. State one effect of magnesium deficiency in green plants.

4. The graph below shows the effect of substrate concentration on the rate of enzyme reaction.

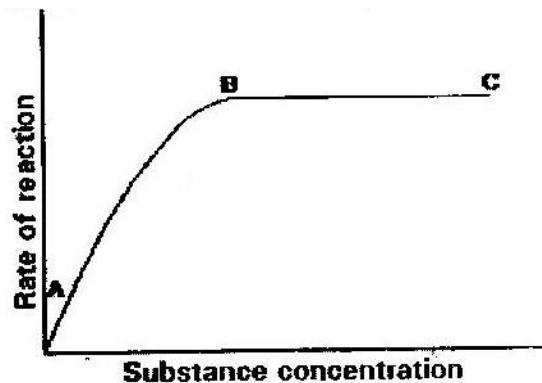

- a) Account for the shape of the graph between
- i) A and B (3mks)
- ii) B and C (2mks)
- b) How can the rate of reaction be increased after point B? (1mk)
- c) State two factors that affect the rate of enzyme reaction. (2mks)
5. a) State the function of co-factors in cell metabolism. (1 mk)
- b) Give one example of a metallic co-factor. (1 mk)
6. Name two mineral elements that are necessary in the synthesis of chlorophyll. (2mks)
7. What is the role of the vascular bundles in plants nutrition? (3mks)
8. Describe what happens during the light stage of photosynthesis. (3mks)
9. Photosynthesis takes place in two stages. Name the part of the chloroplast where
- i) Light stage occurs
- ii) Dark stage occurs (2mks)
- b) How is dark stage dependant on the light stage of photosynthesis? (2mks)
10. A solution of sugarcane was boiled with hydrochloric acid; sodium carbonate was heated with Benedict's solution. An orange precipitate was formed.
- a) Why was the solution boiled with hydrochloric acid? (1mk)
- b) To which class of carbohydrates does sugarcane belong?
- c) Name the type of reaction that takes place when:
- i) Simple sugars combine to form complex sugar. (1mk)
- ii) A complex sugar is broken into simple sugar. (1mk)
- d) State the form in which carbohydrates are stored in:

i) Plants

ii) Animals (2mks)

11. i) Name structural units of lipids (1mk)

ii) State three important functions of lipids in living organisms. (3mks)

12. The diagram below shows an experiment carried out to investigate photosynthesis in a potted plant which has been kept in the dark for 48 hours.

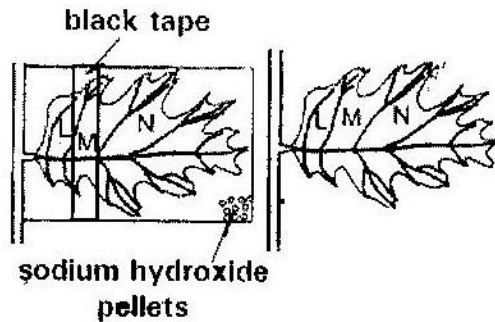

The setup was left in the sunshine for 6 hours. The leaf was tested for starch using iodine solution at the end of the experiment.

a) What would be the colours of the regions of the leaf marked L, M and N? (3mks)

b) What is the function of the sodium hydroxide pellets? (1mk)

CHAPTER SIX

NUTRITION IN ANIMALS

PAST KCSE QUESTIONS ON THE TOPIC

1. a) Name the bacteria found in the root nodules of leguminous plant. (1mk)
b) State the association of the bacteria named in a) above with the leguminous plants. (1mk)
2. a) State the function of co-factors in cell metabolism.
b) Give one example of metallic co-factor.
3. Name the disease in humans that is caused by lack of vitamin C. (1mk)
4. Name a disease caused by lack of each of the following in human diet;
Vitamin D (1mk)
Iodine (1mk)
5. Explain how birds of prey are adapted to obtaining their food. (2mks)
6. Explain biological principles behind the preservation of meat by;
i) Salting
ii) Refrigeration
iii) Canning (3mks)
7. State one similarity and one difference between parasitic and predatory modes of feeding (3mks)
8. In an investigation, the pancreatic duct of a mammal was blocked. It was found that the blood sugar regulation remained normal while food digestion was impaired. Explain these observations. (3mks)

9. Give a reason why lack of roughage in diet often leads to constipation.
10. a) What does the term digestion mean? (2mks)
b) Describe how the mammalian small intestine is adapted to its function. (18mks)
11. State the role of vitamin C in humans. (2mks)
12. a) Distinguish between the terms homodont and heterodont. (1mk)
b) What is the function of carnassial teeth? (1mk)
c) A certain animal has no incisors, no canines, 6 premolars and 6 molars in its upper jaw, in the lower jaw there are 6 incisors, 2 canines, 6 premolars and 6 molars. Write its dental formula.
13. a) State two functions of bile juice in the digestion of food. (2mks)
b) How does substrate concentration affect the rate of enzyme action? (1mk)
14. Name the end-products of the light stage in photosynthesis. (2mks)
15. The diagram below represents a section through a human tooth.

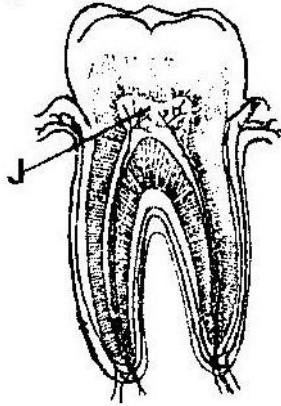

- a) i) Name the type of tooth shown.
ii) Give a reason for your answer in (a) (i) above. (1mk)
- b) State a factor that denatures enzymes. (1mk)
16. a) Name a fat soluble vitamin manufactured by the human body. (1mk)
b) State two functions of potassium ions in the human body. (2mks)
17. a) The action of ptyalin stops at the stomach. Explain. (1mk)
b) State a factor that denatures enzymes. (1mk)
c) Name the features that increase the surface area of small intestines. (2mks)
- 18 Define the following terms (5mks)
- a) Ingestion
b) Digestion
c) Absorption
d) Assimilation

e) Egestion

19 Explain the role of the following organs in the digestion of food in a mammal.

a) Salivary glands

b) Pancrease

c) Liver (3mks)

20 State any three functions of the mucus, which is secreted along the wall of the alimentary canal. (3mks)

21. Explain why the digestion of starch stops after food enters the stomach. (3mks)

22. Give an account of the adaptation of a named herbivore to its mode of feeding. (3mks)

23. What are the contents of gastric juice and what is their role in digestion. (6mks)

24. Liver damage leads to impaired digestion of fats . Explain the statement. (3mks)

25. For each of the following nutrients give one example of a good source and one example of its role in the body.

Nutrient	Food source	Role in the body
Vitamin A		
Iron		
Iodine		
Vitamin D		
Protein		

(10mks)

FORM TWO WORK

CHAPTER 1

TRANSPORT IN PLANTS

PAST KCSE QUESTIONS ON THE TOPIC

1. In an experiment, a leafy shoot was set up in a photometer and kept in a dark room for 2 hours. The set up was then transferred to a well-lit room for 2 hours.
 - a) What was the aim of this experiment? (1mk)
 - b) Explain the results which would be expected in each of the two experiments conditions. (3mks)
2. Explain how drooping of leaves on a hot sunny day is advantageous to plant. (2mks)
3. Explain how environmental factors affect the rate of transpiration in flowering plants. (20mks)
4. The diagram below represents a transverse section of a young stem.

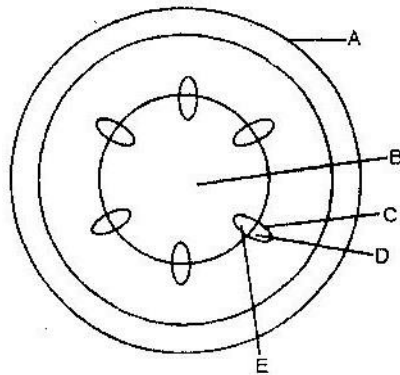

- a) Name the parts labeled A and B (2mks)

A _____

B _____

- b) State the functions of the parts labeled C, D and E

C _____

D _____

E _____

- c) List three differences between the section shown above and one that would be obtained from the root of the same plant (3mks)

5. The diagram below represents the pathway of water from soil into the plant.

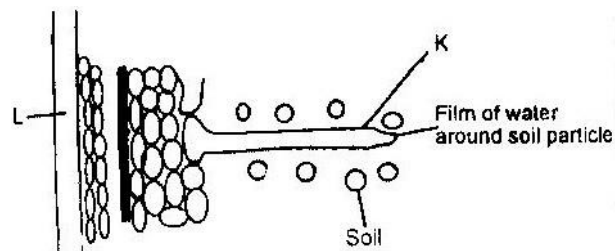

- a) Name the structures labeled K and L

K _____

L _____

(2mks)

- b) Explain how water from the soil reaches the structure labeled L.

(5mks)

- c) Name the process by which mineral salts enter into the plant. (1mk)
6. State two ways in which xylem are adapted to their function. (2mks)
7. What makes young herbaceous plant remain upright? (2mks)
8. The diagram below represents part of phloem tissue

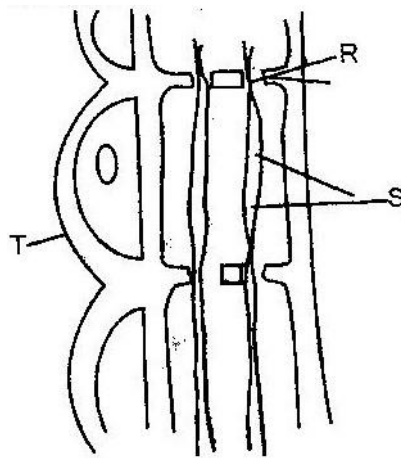

- a) Name the structures labeled R and S and a cell labeled T. (3mks)
- R _____
- S _____
- Cell T _____
- b) State the function of the structure labeled S. (1mk)
- c) Explain why xylem is a mechanical tissue (2mks)
9. Name the
- a) Material that strengthens xylem tissue. (1mk)
- b) Tissue that is removed when the bark of a dicotyledonous plant is ringed. (1mk)

10. How are xylem vessels adapted for support? (1mk)
11. What is the role of vascular bundles in plant nutrition? (3mks)
12. a) Name two tissues which are thickened with lignin. (2mks)
- b) How is support attained in herbaceous plant? (1mk)
13. The diagram below represents a transverse section through a plant organ.

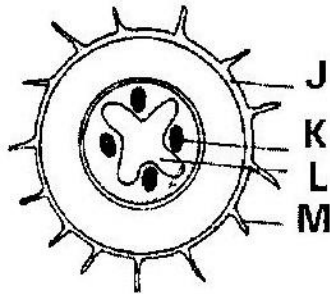

- a) From which plant organ was the section obtained? (1mk)
- b) Give two reasons for your answer in (a) above. (2mks)
- c) Name the parts labeled J, K and L (3mks)
- J _____
- K _____
- L _____
- d) State two functions of the part labeled M. (2mks)
14. Describe how water moves from the soil to the leaves in a tree. (20mks)
15. State two ways in which the root hairs are adapted to their function. (2mks)

16. The diagram below represents a plant tissue.

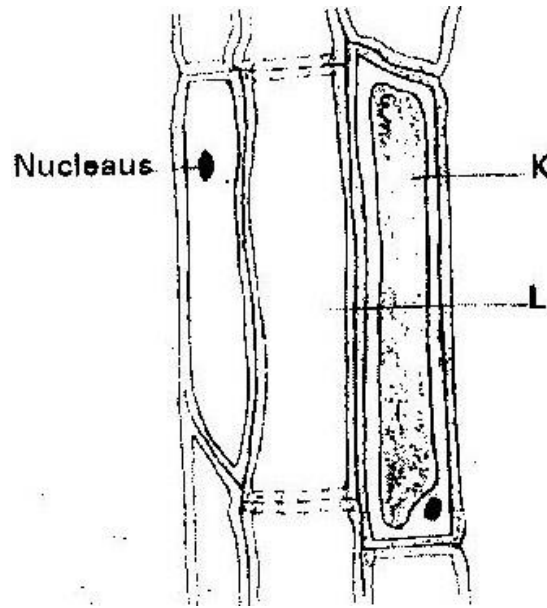

17. In an experiment to determine the effect of ringing on the concentration of sugar in phloem, a ring of bark from the stem of a tree was cut and removed. The amount of sugar in grammes per 16cm^3 piece of bark above the ring was measured over a 24 hour period. Sugar was also measured in the bark of a similar stem of a tree which was not ringed. The results are shown in the table below

Time of the day	Among of sugar in grammes per 16 cm ³ piece of bark	
	Normal stem	Ringed stem
06 45	0.78	0.78
09 45	0.80	0.91
12 45	0.81	1.01
15 45	0.80	1.04
18 45	0.77	1.00
21 45	0.73	0.95
00 45	0.65	0.88

- a) Using the same axes, plot a graph of the amount of sugar against time
(6mks)
- b) At what time was the amount of sugar highest in the;
- Ringed stem (1mk)
 - Normal stem (1mk)
- c) How much sugar would be in the rigged stem if it was measured at 03
45 hours. (2mks)
- d) Give reasons why there was sugar in the stems of both trees at 06 45
hours. (2mks)
- e) Account for the shape of the graph for the tree with ringed stem
between:
- 06 45 hours and 15 45 hours (3mks)

- ii) 15 45 hours and 00 45 hours (2mks)
- f) Other than sugars name two compounds that are translocated in phloem. (2mks)
18. Explain why plants shed off their leaves. (2mks)
19. a) What is the importance of transpiration to plants?
- b) Give adaptive features which enable a plant to reduce the loss of water.

CHAPTER 2

TRANSPORT IN ANIMALS

PAST KCSE QUESTIONS ON THE TOPIC

1. People can die when they inhale gases from burning charcoal in poorly ventilated rooms. What compound is formed in the human body that leads to such deaths? (1mk)

2. Explain why blood from a donor whose blood group is A cannot be transfused into a recipient whose blood group is B. (2mks)

3. State one difference between closed and open circulatory systems. (1mk)

4. a) Give an example of a phylum where all members have
 - i) Open circulatory system
 - ii) Closed circulatory system (2mks)

- b) What are the advantages of the closed circulatory system over the open circulatory system? (5mks)

5. Explain two ways in which mammalian erythrocytes (red blood cells) are adapted to their function (2mks)

6. a) i) Name the blood vessels that link arterioles with venules. (1mk)

ii) Explain four ways in which the vessels you named in (a) above are suited to carrying out their functions. (4mks)

- b) State two ways in which the composition of blood in the

pulmonary arterioles differ from that in the pulmonary venules.

(2mks)

7. Why would carboxyhaemoglobin lead to death? (2mks)
8. Explain how the red blood cells of mammals are adapted for efficient transport of oxygen. (2mks)
9. The chart below is a summary of the blood clotting mechanism in man.

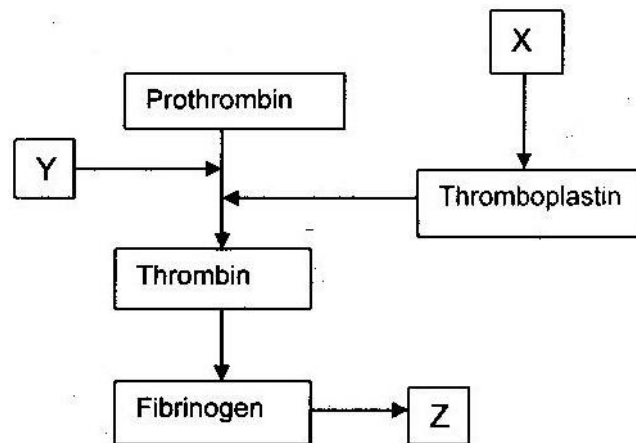

Name

- i) The blood cells represented by X
- ii) Metal ion represented by Y
- iii) The end product of the mechanism represented Z
10. a) How can excess bleeding result in death? (2mks)
- b) Name the process by which the human body naturally stops bleeding. (1mk)
- c) How can low blood volume be brought back to normal? (2mks)
11. a) Name one defect of the circulatory system in humans. (1mk)

- b) State three functions of blood other than transport. (3mks)
12. a) What prevents blood in veins from flowing backwards? (1mk)
- b) State two ways in which the red blood cells are adapted to their function. (2mks)
13. State one way by which HIV/AIDS is transmitted from mother to child. (1mk)
14. Explain how the various components of blood are adapted for their function. (20mks)
15. Distinguish between blood, plasma, serum, tissue fluid and lymph. (10mks)
16. a) A patient whose blood group is A died shortly after receiving blood from a person of blood group B. Explain the possible cause of death of the patient. (2mks)
- b) A person of blood group AB requires a transfusion.
- i) Name the blood groups of the possible donors (2mks)
- ii) Give reasons for your answer in (i) above. (2mks)
17. Differentiate between active immunity and passive immunity. (2mks)
18. Explain why a person can catch a cold several times in a year but only catches measles once in his or her lifetime. (2mks)
19. Most carbon dioxide is transported from tissues to the lungs within the red blood cells and not in the blood plasma. Give two advantages of this mode of transport. (2mks)
20. What is the importance of tissue fluid? (2mks)

CHAPTER 3

GASEOUS EXCHANGE

PAST KCSE QUESTIONS ON THE TOPIC

1. Discuss how gaseous exchange occurs in
 - a) Terrestrial Insects (9mks)
 - b) Bony fish (11mks)
2. a) Explain how mammalian lungs are adapted for gaseous exchange. (8mks)
 - b) Describe how carbon dioxide is produced by
 - i) Respiring muscle cells reaches the alveolar cavities in mammalian lungs.
 - ii) Respiring mesophyll cells of flowering plants reaches the atmosphere. (12 mks)
3. a) Describe the path taken by carbon dioxide released from the tissues of an insect to the atmosphere.
 - b) Name two structures used for gaseous exchange in plants. (2mks)
4. Why are gills in fish highly vascularized? (1mk)
5. Describe the
 - a) Process of inhalation in mammals. (10 mks)
 - b) Mechanism of opening and closing of stomata (10 mks)
6. Name three sites where gaseous exchange takes place in terrestrial plants. (3mks)
7. How is aerenchyma tissue adapted to its function? (2mks)

8. The diagram below represents a part of the rib cage.

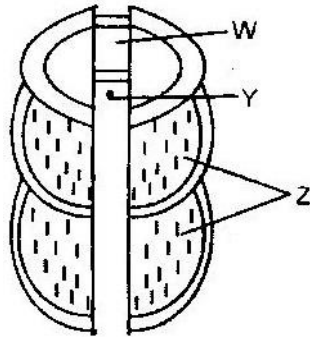

- a) Name parts labeled W, Y and Z.
- b) How does the part labeled Z facilitates breathing in? (1mk)
9. State two ways in which floating leaves of aquatic plants are adapted to gaseous exchange. (2mks)
10. a) Name two structures for gaseous exchange in aquatic plants. (2mks)
- b) What is the effect of contraction of the diaphragm muscles during breathing in mammals? (3mks)
11. The diagram below represents some gaseous exchange structures in humans.

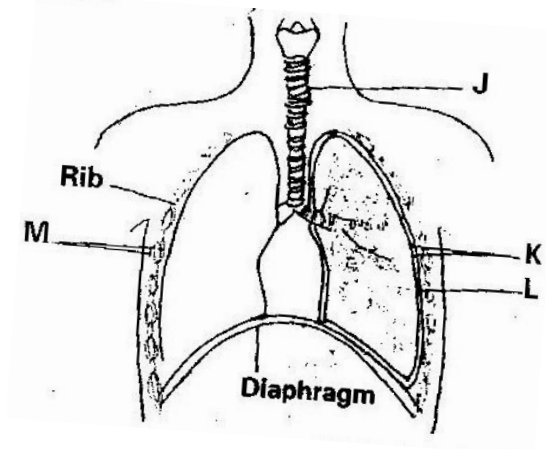

- a) Name the structure labeled K, L and M (3mks)
- b) How is the structure labeled J suited to its functions? (3mks)
- c) Name the process by which inhaled air moves from the structure labeled L into blood capillaries. (1mk)
- d) Give the scientific name of the organism that causes tuberculosis in humans. (1mk)
12. State three factors that make alveolus adapted to its function. (3mks)
13. Explain how the alveoli are ventilated.
14. Explain why water logging of the soil may lead to death in plants. (2mks)
15. Write three advantages of breathing through nose than through mouth. (3mks)
16. State and explain ways the leaves are adapted for gaseous exchange (4mks)
17. Name three gaseous constituents involved in gaseous exchange in plants. (3mks)
18. Name three sites of gaseous exchange in frogs. (3mks)
19. Name the main site of gaseous exchange in
- a) Mammals
- b) Fish
- c) Leaves
- d) Amoeba (4mks)
20. Name the physiological process by which gas exchange takes place at the respiratory surface in animals and plants (1mk)

CHAPTER FOUR

RESPIRATION

PAST KCSE QUESTIONS ON THE TOPIC

1. The diagram below shows a set up that was used to demonstrate fermentation.

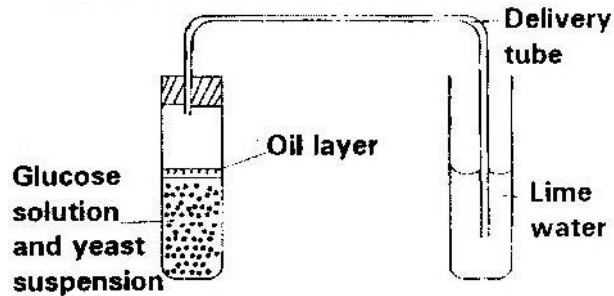

Glucose solution was boiled and oil added on top of it. The glucose solution was then allowed to cool before adding the yeast suspension.

- a) Why was the glucose solution boiled before adding the yeast suspension? (1mk)
- b) What was the importance of cooling the glucose solution before adding the yeast suspension? (1mk)
- c) What was the use of the oil in the experiment? (1mk)
- d) What observation would be made in test tube B at the end of the experiment (1mk)
- e) Suggest a control for this experiment (1mk)
2. Give two reasons why accumulation of lactic acid during vigorous exercise lead to an increase in heart beat. (2mks)
3. A process that occurs in plants is represented by the equation below.

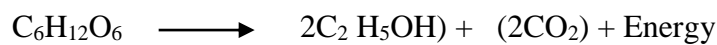

Glucose Ethanol Carbon Dioxide

- a) Name the process (1mk)
- b) State the economic importance of process name in (a) above. (1mk)
4. Other than carbon dioxide, name the other products of anaerobic respiration in plants. (2mks)
5. Name the substance which accumulates in muscles when respiration occurs with insufficient oxygen. (1mk)
6. a) In what form is energy stored in muscles? (1mk)
- b) State the economic importance of anaerobic respiration in plants. (2mks)
7. State four ways in which respiratory surfaces are suited to their function. (4mks)
8. a) A dog weighing 15.2kg requires 216kJ while a mouse weighing 50g requires 2736KJ per day. Explain. (2mks)
- b) What is the end product of respiration in animals when there is insufficient oxygen supply? (1mk)
9. a) Name the products of anaerobic respiration in:
- i) Plants (1mk)
- ii) Animals (1mk)
- b) What is oxygen debt? (1mk)
10. $5C_{51}H_{98}O_6 + 145O_2 \longrightarrow 1 O_2CO_2 + 98 H_2O + \text{energy}$
- The above equation shows an oxidation reaction of food substances.

- a) What do you understand by the term respiratory quotient? (1mk)
- b) Determine respiratory quotient of the oxidation of food substance. (2mks)
- c) Identify the food substances. (1mk)
- 11 Write differences between aerobic respiration and photosynthesis. (4mks)
12. Below is a diagram of an organelle that is involved in aerobic respiration.

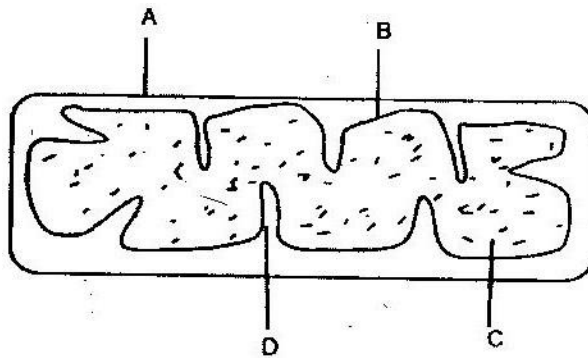

- a) Name the organelle (1mk)
- b) Name the parts labeled A, B, and C. (3mks)
- c) What is the purpose of the folding labeled D? (1mk)
- d) Give the chemical compound which is formed in the organelle and forms the immediate source of energy.

CHAPTER 5

EXCRETION AND HOMEOSTASIS

PAST K.C.S.E QUESTIONS ON THE TOPIC

1. In an investigation the pancreatic duct of a mammal was blocked. It was found that the blood sugar regulation remained normal while food digestion was impaired. Explain these observations. (2 marks)
2. (a) Explain why the body temperature of a healthy human being must rise up to 39⁰c on a humid day. (2 marks)
(b) In an experiment a piece of brain was removed from rat. It was found that the rat had large fluctuations of body temperatures suggest the part of the brain that had been removed. (1 mark)
3. (a) Explain why sweat accumulates on a person's skin in a hot humid Environment. (2 marks)
(b) Name the specific part of the brain that triggers sweating. (1 marks)
4. Explain why some desert animals excrete uric acid rather than ammonia. (2 marks)
5. State the role of the following hormones in the body
(a) Insulin (3 marks)
(b) Antidiuretic Hormone (3 marks)
6. What osmoregulatory changes would take place in a marine amoeba if it was transferred to a fresh water environment?
7. Name two components of blood that are not present in glomerular filtrate.

(2 marks)

8. How would one find out from a sample of urine whether a person is suffering from diabetes mellitus? (2 marks)

9. When is glycogen, which is stored in the liver, converted into glucose and released into the blood? (2 marks)

10. A person was found to pass out large volumes of dilute urine frequently. Name the

(a) Diseases the person was suffering from (1 marks)

(b) Hormone that was deficient (1 mark)

11. State the importance of osmoregulation in organisms (2 marks)

12. What happens to excess fatty acids and glycerol in the body? (2 marks)

13. Give reasons for each of the following

(a) Constant body temperature is maintained in mammals (1 mark)

(b) Low blood sugar level is harmful to the body (2 marks)

14. The temperature of a person taken before during and after taking a cold bath. The results are shown in the graph

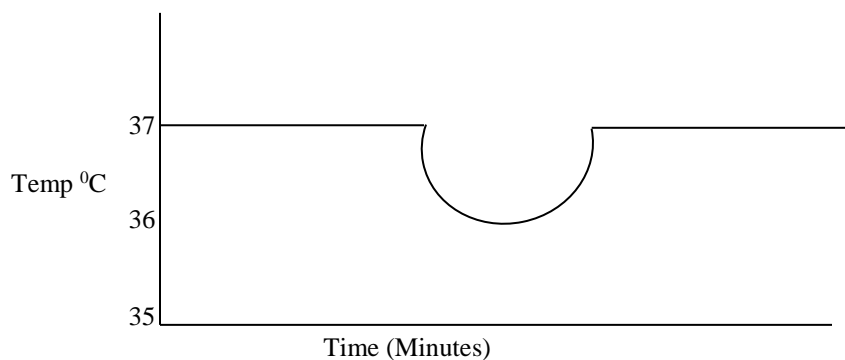

- (a) Explain why the temperature fell during the bath (2 marks)
- (b) What changes appeared in the skin that enabled the body temperature to return to normal. (2 marks)
15. (a) Name the fluid that is produced by sebaceous glands (1 mark)
- (b) What is the role of sweat on the human skin? (2 marks)
16. State the role of insulin in the human body? (1 mark)
17. Describe how the human kidney functions. (20 marks)
18. (a) What is the meaning of the following terms:
- (i) Homeostasis (1 mark)
- (ii) Osmoregulation (1 mark)
19. (a) Explain what happens to excess amino acids in the liver of humans. (3 marks)
- (b) Which portions of the human nephrons are only found in the cortex? (3 marks)
- (c) (i) What would happen if a person produced less antidiuretic hormone? (1 mark)
- (ii) What term is given to the condition described in (c) (i) above? (1 mark)
20. Define the following terms
- (a) Excretion
- (b) Secretion
- (c) Egestion (3 marks)

21. Name the components of blood that do not enter the renal tubule in mammals

(2 marks)

22. The table below shows the approximate percent concentration of various components in blood plasma entering the kidney glomerular filtrate and urine of a healthy human being.

Component	Plasma	Glomerular	Urine Filtrate
Water	90	90	94
Glucose	0.1	0.1	0
Amino Acids	0.05	0.05	0
Plasma proteins	8.0	0	0
Urea	0.03	0.03	2.0
In organic ions	0.72	0.72	1.5

- (b) Name the process responsible for the formation of glomerular filtrate.
- (c) What process is responsible for the absence of glucose and amino acids in urine?
- (d) Explain why there are no plasma proteins in the glomerular filtrate
- (e) Besides plasma proteins what other major component of blood is absent in the glomerular filtrate.
- (f) Why is the concentration of urea in urine much higher than its concentration in the glomerular filtrate?

23. When the environmental temperature is very high, some animals urinate on their legs or lick the sides of their body. How does this help in temperature regulation?
24. Fish are able to use more of their food intake for growth than mammals. Suggest an explanation for this.
25. Explain the term negative feedback
26. Study the diagram below and answer the questions that follow.

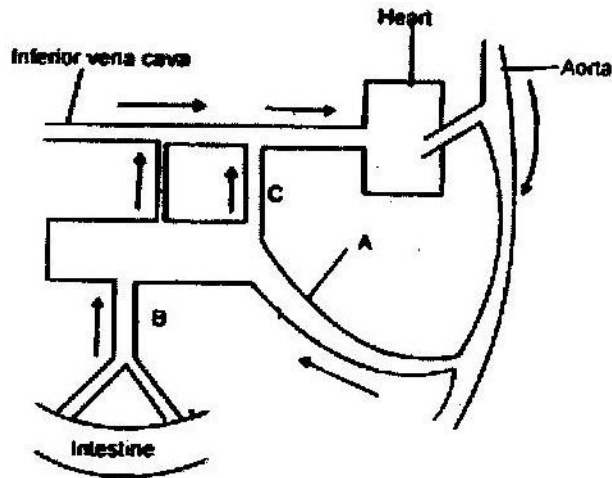

- (a) Name the blood vessels labeled A, B and C.
- (b) If the animal has recently fed on a diet which is rich in proteins and carbohydrates in which of the vessels labeled A, B, and C would you expect to find the highest concentration of:
- Glucose
 - Amino acids
 - Carbon (IV) oxide
 - Oxygen
 - Urea
- (c) During fasting, the level of blood glucose in vessels C may be higher than the level in vessel B explain

FORM 3 WORK

CHAPTER 1

CLASSIFICATION II

PAST KCSE QUESTIONS ON THE TOPIC

1. State two ways in which some fungi are harmful to man (2 marks)
2. The diagram below represents a fern

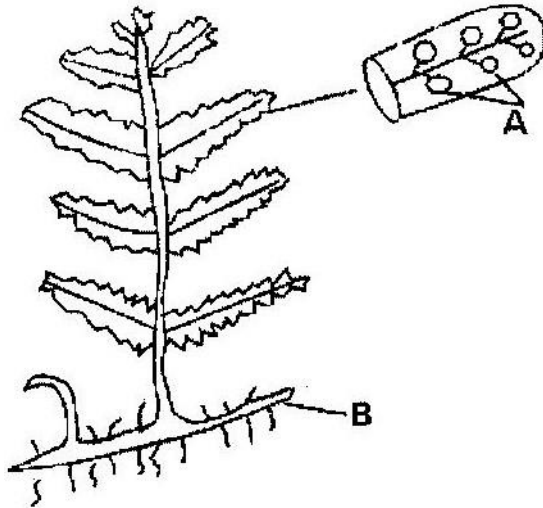

Name

- (a) Parts labeled A and B (2 marks)
 - (b) The division which the plant belongs (1 mark)
3. An organism with an exoskeleton, segmented body, two pairs of legs per segment, a pair of eyes and a pair of short antennae belongs to the phylum (1 mark)
 4. When are two organisms considered to belong to the same species? (2 marks)
 5. A student caught an animal which had the following characteristics;
 - Body divided into two parts
 - Simple eyes

- Eight legs

The animal belongs to the class (1 mark)

6. Below is a list of organisms, which belong to classes insecta, myriapoda and arachnida. Tick, centipede, praying mantis, tsetse fly. Millipede and spider. Place the organisms in their respective classes in the table below. Give reasons in each case.

Class	Organisms	Reasons
Insecta		
Myriapoda		
Arachnida		

7. State two characteristics features of members of division bryophyte (2 marks)
8. State two ways in which some fungi are beneficial to humans (2 marks)
9. Other than having many features in common state the other characteristics of species (1 mark)
10. Beside the abdomen, name the other body part of members of arachnida (1 mark)
11. Name the phylum whose members possess notochord. (1 mark)
12. Name the class in the phylum arthropoda which has the largest number of individuals (1 mark)
13. To which class does an animal with two body parts and four pairs of legs belong? (1 mark)

14. (a) Name two organisms that cause food spoilage (2 marks)
- (b) Name two methods of food preservation and for each state the biological principal behind it. (2 marks)
15. (a) List two characteristics that mammals share with birds (2 marks)
- (b) State two major characteristics that are unique to mammals (2 marks)
16. What two characteristics distinguish animals in phylum chordata? (2 marks)
17. The diagram below shows a plant

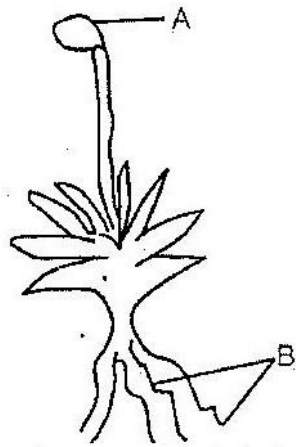

- (a) Name the parts labeled A and B (2 marks)
- (b) Name the division to which the plant belongs (1 mark)
- (c) Which is the dominant generation of the plant in the diagram? (1 mark)
- (d) State three characteristics of the organisms in the division named (b) above?
18. What three characteristics are used to divide the arthropods into classes? (3 marks)
19. (a) Write two differences between algae and fungi (2 marks)
- (b) Give the economic importance of algae (1 mark)

20. (a) What is alteration of generations? (3 marks)
- (b) Name two divisions in plant kingdom that shows alternation of generation (2 marks)
21. (a) A millipede, grasshopper and crayfish all belong to phylum arthropoda. Mention three major characteristics that they have in common. (3 marks)
- (b) The specific name of Irish potato is solanum Tuberrasum
- (i) Identify two errors that have been made when writing the name
- (ii) What is the species name of Irish potato?
- (c) An ecologist came across a plant with the following characteristics, green in colour, non- flowering, compound leaves and sori on the underside of the leaflets. State the probable division of the plant. (1 mark)
22. An organism with an exoskeleton, segmented body, two pairs of legs per segment, a pair of eyes and a pair of short antennae belongs to the class (1 mark)
23. List the main characteristics that are used to sub- divide arthropods into classes (2 marks)
24. Name the main method of reproduction among bacteria. (1 mark)

CHAPTER 2

ECOLOGY

PAST KCSE QUESTIONS ON THE TOPIC

1. State how excessive use of pesticides may affect soil fertility
2. The graph below represents a population growth of a certain herbivore in a grassland ecosystem over a period of time.

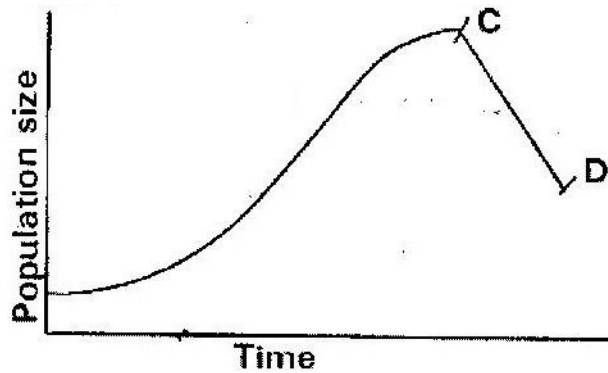

Suggest three factors that could have caused the population change between C and D

(3 marks)

3. A biologist carried out a study to investigate the growth of a certain species of herbivorous bony fish and the factors influencing plant and animal life in four lakes A, B, C and D. The lakes were located in the same geographical area. Two of the lakes A and B were found to contain hard water due to presence of high content of calcium slats. The mean body length of 2 year old fish, amount of plant life and invertebrates biomass in each lake were determines. The data was as shown in

Lakes	Mean body length (cm)	Type of water	Amount of plant life	Invertebrate biomass (g/cm ³)			
				Insects	Snails	Crabs	Worms
A	31.2	Hard	1050	11	300	10	180
B	28.6	Hard	950	72	100	9	90
C	18.4	Soft	1.2	97	0	2	20
D	16.3	Soft	0.5	99	0	1	10

- (a) Describe the procedure that may have been used to determine the mean body length of the fish (6 marks)
- (b) What are the likely reasons for the difference in the mean body length of the fish living in lakes A and D? (4 marks)
- (c) Suggest one reason for the absence of snails in lakes C and D? (1 mark)
- (d) (i) Name any six abiotic (physical) factors that are likely to influence the plant and animal life in lake A. (3 marks)
- (ii) Explain how each of the factors named in (i) may influence the plant and animals life in Lake A. (6 marks)

4. During an ecological study of a lake a group of students recorded the following observations.

- (i) Planktonic crustaceans feed on planktonic algae
- (ii) Small fish feed on planktonic crustaceans worms and insect larvae
- (iii) Worms feed on insect larvae

- (iv) Bird species feeds on small fish planktonic crustaceans and worms
 - (v) Insect larvae feed on small fish
- (a) From this record of observations construct a feed web (5 marks)
- (b) From the food web you have constructed in (a) above isolate and write down a food chain that ends with
- (i) Bird species as a secondary consumer (1 mark)
 - (ii) Large fish as tertiary consumer (1 mark)
- (c) The biomass of the producers in the lake was found to be greater than that of primary consumers. Give an explanation for this observation? (1 mark)
- (d) Using either the observations recorded by the students or the food web you have constructed name (1 mark)
- (i) Two organisms that compete for food in the lake. (2 marks)
 - (ii) The source of food the organisms in d (i) above compete for (1 mark)
- (e) (i) State three ways by which many may interfere with this lake ecosystem (3 marks)
- (ii) Explain how each of the ways you have states may affect life in the lake? (6 marks)

5. In an investigation, a student collected two plants A and B. Plant A had hairy leaves and epidermis. Leaves of plant B

(i) Plant A (1 mark)

(ii) Plant B (1 mark)

6. An investigation was carried out between 1964 and 1973 to study the changes of fish population in a certain small lake. Four species of fish A, B, C and D were found to live in this lake. In 1965 a factory was built near the lake and was found to discharge hot water into the lake raising the average temperature from 25⁰C to 30⁰C. In 1967 sewage and industrial waste from a nearby town was diverted into the lake was stopped. The fish population during the period of investigation is shown in the table below.

Fish species	Fish populations during the period						
	1964	1966	1969	1970	1971	1972	1973
A	6102	223	26	106	660	4071	7512
B	208	30	11	22	63	311	405
C	36	100	0	0	0	0	0
D	4521	272	23	27	79	400	617

- (a) (i) In which year were the fish populations lowest?
- (ii) State the factors that might have caused the lowest fish populations during the year you have stated in (a) (i) above (3 marks)
- (iii) Explain how each factor you have stated in (a) (ii) above could have brought about the changes in fish populations (11 marks)
- (b) (i) What is the difference in the rate of population recovery of species A and

D? (1 mark)

(ii) Suggest two biological factors that could have led to this difference (2 marks)

(c) (i) State a method that might have been used to estimate the fish population in the lake (1 mark)

(ii) State one disadvantage of the method you have stated in (c) (i) above (1 mark)

7. Industrial wastes may contain metallic pollutants. State how such pollutants may indirectly reach and accumulate in the human body if the wastes were dumped into rivers.

8. State three measures that can be taken to control infection of man by protozoan parasites (3 marks)

9. The chart below shows a feeding relationship in a certain ecosystem

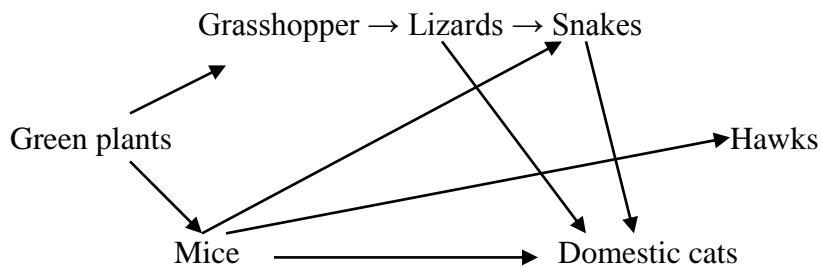

- (a) Construct two food chains ending with a tertiary consumer in each case (2 marks)
- (b) Which organisms has the largest variety of predators in the food web? (1 mark)
- (c) Name secondary consumers in the food web (2 marks)
- (d) Suggest three ways in which the ecosystem would be affected if there was prolonged drought (3 marks)

10. To estimate the population size of crabs in a certain lagoon, traps were laid at random. 400 crabs were caught, marked and released back into the lagoon. Four days later, traps were laid again and 374 crabs were caught. Out of the 374 crabs, 80 were found to have been marked.

- (a) Calculate the population size of the crabs in the lagoon using the formula below

$$N = \frac{n \times M}{M}$$

Where

N= Total population of crabs in the lagoon

n= Total number of crabs in the second catch

M= Number marked crabs during the first catch

M= Number of marked crabs in the second catch. (2 marks)

- (b) State two assumptions that were made during the investigation (2 marks)
- (b) What is the name given to this method of estimating the population size? (1 mark)

11. The figure below represents a feeding relationship in an ecosystem

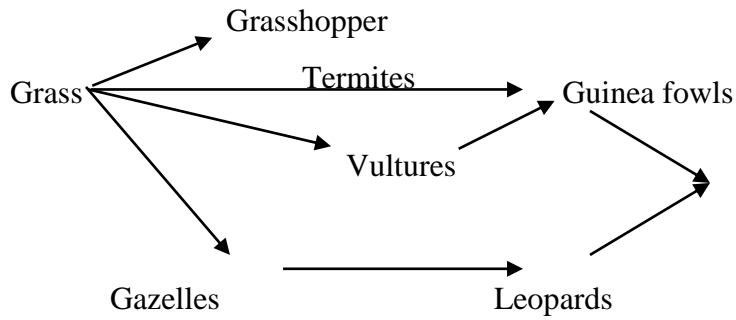

- (a) Write down the food chains in which the guinea fowls are secondary consumers (1 mark)
- (b) What would be the short term effects on the eco- system of lions invaded the area? (3 marks)
- (c) Name the organisms through which energy from the sun enters the food web. (1 mark)

12. The diagram below represents a simplified nitrogen cycle

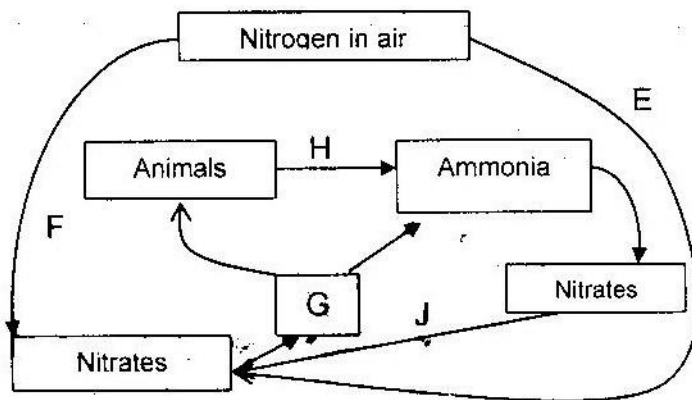

- (a) Name the organisms that causes processes E and J (2 marks)
- (b) Name the processes represented by F and H (2 marks)
- (c) Name the group of organisms represented by c (i)
13. (a) Distinguish between a community and a population (2 marks)
- (b) Describe how a population of grasshopper in a given area can be estimated (5 marks)
14. Explain how the various activities of man have caused pollution of air (20 marks)
15. Explain how birds of prey are adapted to obtaining their food (2 marks)
16. (a) Name the crop infested by phytophthora infestants and the disease it causes
- | | |
|---------|---|
| Crop | - |
| Disease | - |
- (b) State four control measures against the diseases (4 marks)
17. Explain why the carrying capacity for wild animals is higher than for cattle in a given piece of land (2 marks)
18. (a) What is meant by
- (i) Autecology (1 mark)
- (ii) Synecology (1 mark)
- (b) The number and distribution of stomata on three different leaves are shown in the table below

Leaf	Number of stomata	
	Upper epidermis	Lower Epidermis
A	300	0
B	150	200
C	02	13

Suggest the possible habitat of the plants from which the leaves were obtained.

(3 marks)

Leaf	Habitat
A	_____
B	_____
C	_____

(c) State the modification found in the stomata of leaf C

19. After an ecological study of feeding relationships students constructed the food web below

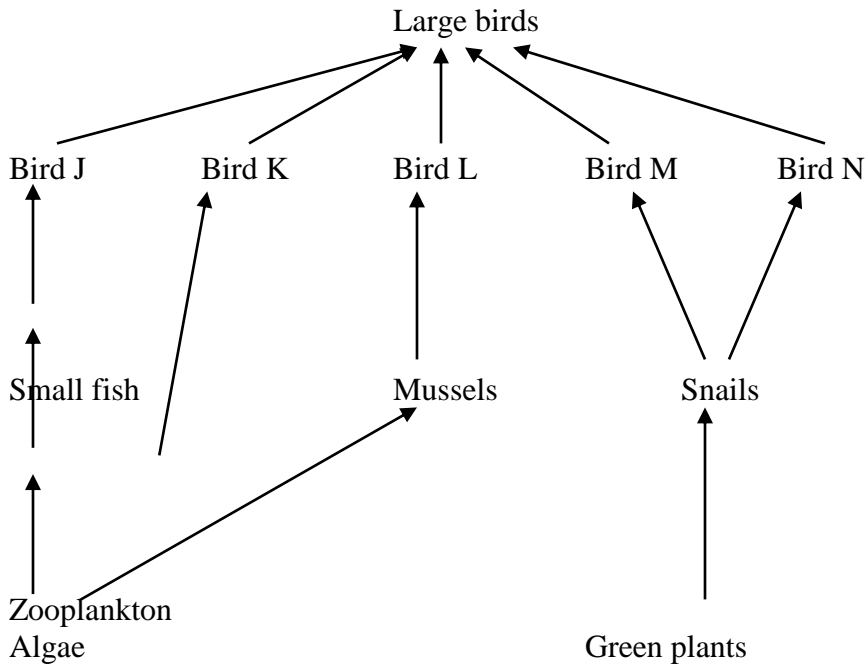

- (a) Name the process through which energy from the sun is incorporated into the food web (1 mark)
- (b) State the mode of feeding of the birds in the food web (1 mark)
- (c) Name two ecosystem in which the organisms in the food web live(2 marks)
- (d) From the information in the food web construct a food chain with the large bird as a quarter – nary consumer (1 mark)
- (e) What would happen to the organisms in the food web if bird N migrated?
- (f) Not all energy from one trophic level is available to the next level. Explain (3 marks)
- (g) (i) Two organisms, which display a role in the ecosystems, are not included in the food web. Name them. (1 mark)
- (ii) State the role played by the organisms named g (i) above. (1 mark)

(h) (i) State three human activities that would affect the ecosystems (3 marks)

(ii) How would the activities stated in h (i) above affect the ecosystems?

(3 marks)

20. How is aerenchyma tissue adapted to its functions?

(2 marks)

21. Explain how abiotic factors affect plants

(20 marks)

22. What is the importance of the following in an ecosystem?

(3 marks)

(a) Decomposers

(b) Predation

23. Chart below represents a simplified nitrogen cycle

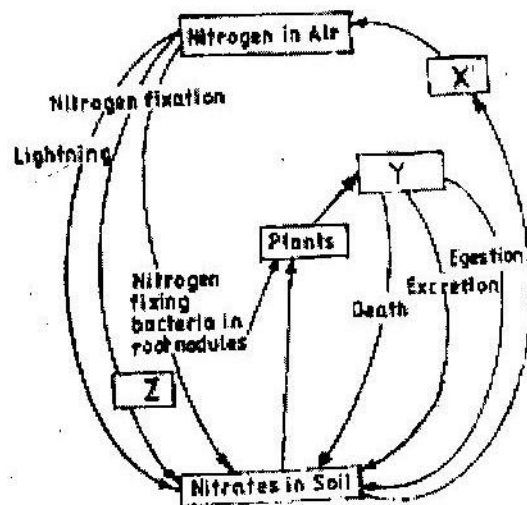

What is represented by X, Y and Z?

(3 marks)

24.

- (a) Distinguish between pyramid of numbers and pyramid of Biomass
(2 marks)
- (b) Give three reasons for loss of energy from one trophic level to another in a food chain.
(3 marks)
- (c) Describe how the belt transect can be used in estimating the population of a shrub in a grassland
(2 marks)

25.

- (a) Distinguish between population and community
(2 marks)
- (b) Name a method that could be used to estimate the population size of the following organisms
 - (i) Fish in a pond
(1 mark)
 - (ii) Black jack in a garden
(1 mark)

26.

State two ways in which schistosoma species is adapted to parasitic mode of life

27.

Describe causes and methods of controlling water pollution (20 marks)

28. (a) What is biological control of population growth? (2 marks)
- (b) Describe one example where biological control has been used successfully (2 marks)
- (c) Explain why the number of predators in any ecosystem is less than the number of their prey (1 mark)

29. Suggest reasons to account for the following observations.

- (b) Antelopes are more commonly found in open grassland while giraffe while giraffes are commonly found in wooded areas. (2 marks)
- (b) In the savannah there is a wider variety of herbivores in wooded areas than in open grassland (1 mark)
- (c) Removal of predators for an herbivore may in the long run lead to a decrease in its population

30. Explain why primary productivity decreases with depth in aquatic environments. (2 marks)

31. The following is a simplified drawing of nitrogen cycle.

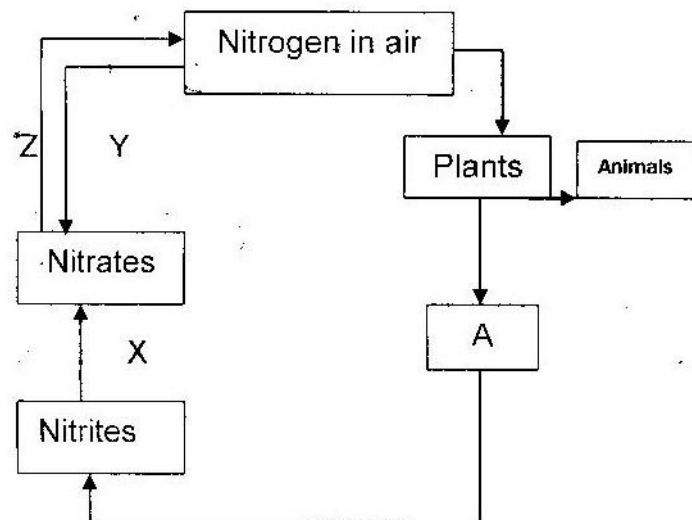

(a) Identify the compound named A (1 mark)

(b) Name the processes

X _____

Y _____

Z _____

(c) In what form is nitrogen found in plants and animals?

32. An investigation was carried out to study the type of food eaten by birds found in forest and savannah in a certain area. The table below compares the feeding habitats of the birds found in a closed forest area and an open dry savannah of the area.

Diet	Percentage of birds	
	Forest	Savannah
Insects only	60	50
Vertebrates	10	10
Seeds	5	20
Fruits	25	10
Other plant materials	5	5
Number	120	60

- (a) Work out the difference in the number of bird species the feed on:
- (i) Fruits found in forest and savannah (2 marks)
 - (ii) Seed found in forest and savannah (2 marks)
- (b) State two factors that may cause this difference in (a) above (2 marks)
- (c) In another investigation two vertebrate species from the savannah were counted and recorded on monthly basis as shown below.

Year	Month	Species A	Species B
1998	July	96	240
1998	August	79	590
1998	September	75	900
1998	October	87	750
1998	November	-	230
1998	December	99	80
1998	January	129	200
1998	February	96	330
1998	March	99	300
1998	April	79	320
1998	May	135	90
1998	June	104	450

- (i) Which species show more fluctuation in numbers? (1 mark)
- (ii) Suggest an explanation of this (3 marks)
- (d) Suggest two ways by which the savannah environment can be destroyed and how it can be conserved (4 marks)

CHAPTER 3

REPRODUCTION IN PLANTS AND ANIMALS

PAST KCSE QUESTIONS ON THE TOPIC

1. At what stage of mitosis do chromosomes replicate to form daughter chromatid?
(1 mark)
2. Fill in the blank spaces in the statement below
After fertilization of an ovule _____ develops into a testa and _____
develops into a testa and _____ develops into endosperm. (2 marks)
3. State the difference between the composition of maternal blood entering the
placenta and material blood leaving the placenta (3 marks)
4. After four months of pregnancy the ovaries of a woman can be removed without
terminating pregnancy. However during the first four months of pregnancy the
ovaries must remain intact if pregnancy is to be maintained. Explain these
observations (3 marks)
5. Name two mechanisms that prevent self pollination in flowers that have both
male and female parts (2 marks)
6. State three characteristics that ensure cross pollination takes place in flowering
plants (3 marks)
7. Give a reason why it is necessary for frogs to lay many eggs (1 mark)
8. A flower was found to have the following characteristics
 - Inconspicuous petals
 - Long feathery stigma
 - Small light pollen grains

- (a) What is the likely agent of pollination of the flower? (1 mark)
- (b) What is the significance of the long feathery stigma in the flower (1 mark)
9. State two ways by which the human Immuno Deficiency virus (HIV) is transmitted other than sexual intercourse? (2 marks)
10. Explain why sexual reproduction is important in organisms (3 marks)
11. State two disadvantages of self- pollination (2 marks)
12. The chart below shows the number of chromosomes before and after cell division and fertilization in a mammal.

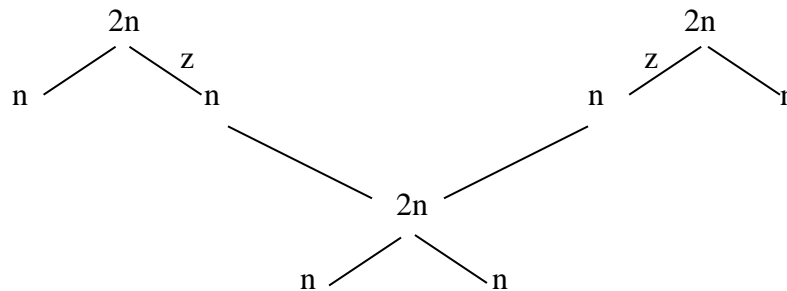

- (a) What type of cell division takes place at Z? (1 mark)
- (b) Where in the body of a female does process Z occur? (1 mark)
- (c) On the chart indicate the position of parent and gametes (2 marks)
13. (a) What is meant by the terms
- (i) Epigynous flower (1 mark)
- (ii) Staminate flower (1 mark)
- (b) How are the male parts of wind- pollinated flowers adapted to their function? (4 marks)
14. Name the part of a flower that developed into:

- (a) Seed (1 mark)
- (b) Fruit (1 mark)
15. (a) State two processes which occur during anaphase of mitosis (2 marks)
- (b) What is the significance of meiosis? (2 marks)
16. (a) Explain how the following prevents self- pollination:
- (i) Protoandry (1 mark)
- (ii) Self- sterility (1 mark)
- (b) Give three advantages of cross- pollination (3 marks)
17. The diagram below represents a human foetus in a uterus

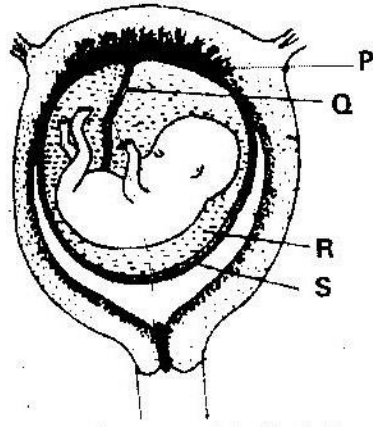

- (a) Name the part labeled S (1 mark)
- (b) (i) Name the types of blood vessels found in the structure labeled Q (2 marks)
- (ii) State the difference in composition of blood in the vessels named (b) (i) above (2 marks)
- (c) Name two features that enable the structure labeled P carry out its function (2 mark)

(d) State the role of the part labeled R (1 mark)

18. The diagram below represents a stage during cell division

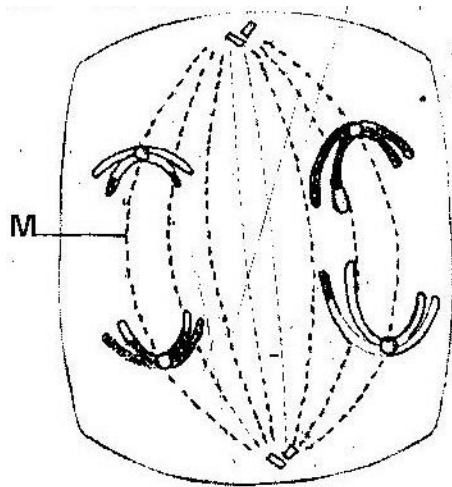

(a) (i) Identify the stage of cell division (1 mark)

(ii) Give three reasons for your answer (a) (i) above (2 marks)

(b) Name the structure labeled M (1 mark)

19. State two disadvantages of sexual reproduction in animals (2 marks)

20.

(a) What is meant by the following terms?

(i) Protandry (1 mark)

(ii) Self- sterility (1 mark)

(b) The diagram below shows a stage during fertilization in plant

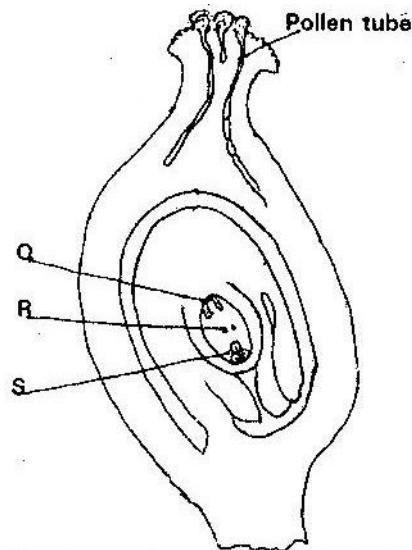

- (i) Name the parts labeled Q, R, and S (3 marks)
- (ii) State two functions of the pollen tube (2 marks)
- (c) On the diagram, label the micropyle (1 mark)

21. (a) Describe how insect pollinated flowers are adapted to pollination (6 marks)

(b) Describe the role of each of the following hormones in the human menstrual cycle.

- (i) Oestrogen
- (ii) Progesterone
- (iii) Luteinizing hormone (3 marks)

22. Describe the role of hormones in the human menstrual cycle (20 marks)

23. What part does the placenta play in the

- (i) Nutrition of the embryo
- (ii) Protection of the embryo (4 marks)

CHAPTER FOUR

GROWTH AND DEVELOPMENT

PAST KCSE QUESTION ON THE TOPIC

1. Explain why several auxiliary buds sprout when a terminal bud in a young tree is removed.
2. Account for loss in dry weight of cotyledons in a germinating bean seed.
3. What is the effect of gibberellins on shoots of plants?
4. A student set up an experiment as shown in the diagram below

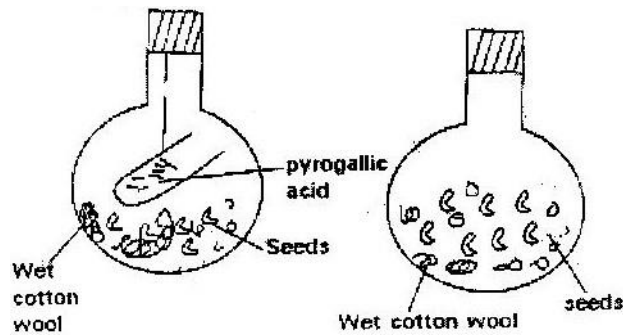

The set up was left at room temperature for a week

- (a) What was the aim of the experiment?
 - (b) What would be the expected results at the end of the experiment?
5. State two advantages of metamorphosis to the life of insects
 6. During germination and early growth, the dry weight of endosperm decreases while that of the embryo increases. Explain
 7. In an experiment, a group of student set up four glass jars as shown in the diagram below jar A, B and C were maintained at 25⁰C for 7 days. While Jar D was maintained at 0⁰ c for the same period of time.

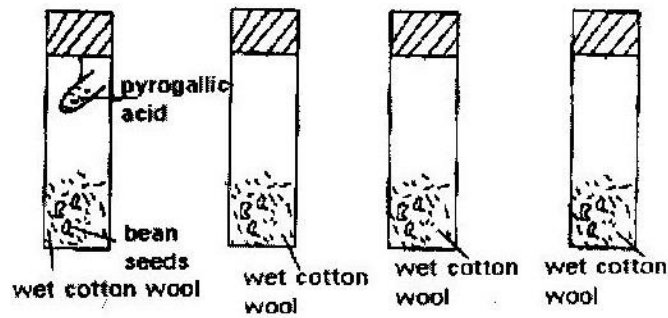

- (a) What was this set up supposed to investigate?
 - (b) Why was pyrogallol acid included in glass jar A?
 - (c) Explain why glass jar C and D were included in the experiment
 - (d) What result would you expect in glass jar A and B at the end of the experiment?
 - (e) State two artificial ways of breaking seed dormancy
8. Removal of the apical bud from the shrub is a practice that results in the development of the lateral buds which later form the branches.
- (a) Give reasons for the development of the lateral branches after the removal of the apical bud
 - (b) Suggest one application of this practice
 - (c) What is the importance of this practice?
9. In an experiment some germination seeds were placed in a large airtight flask and left for four days
- (a) Suggest the expected changes in the composition of gases in the flask on the fifth day
 - (b) Give four reasons for your answer in (a) above
 - (c) Name two factors that cause dormancy in seeds
10. (a) Distinguish between epigeal and hypogeal germination (1 mark)

(b) Why is oxygen necessary in the germination of seeds? (2 marks)

11. An experiment was carried out to investigate the effect of hormones on growth of lateral buds of three pea plants

The shoots were treated as follows:

Shoot A- Apical bud was removed

Shoot B – Apical bud was removed and gibberellic acid placed on the cut shoot

Shoot C- Apical bud was left intact.

The length of the branches developing from the lateral buds were determines at regular intervals

The results obtained are as shown in the table below

Time (days)	Length of branches in mm		
	Shoot A	Shoot B	Shoot C
0	3	3	3
2	10	12	3
4	28	48	8
6	50	90	14
8	80	120	20
10	118	152	26

(a) Using the same axes, draw graphs to show the length of branches against time (8 marks)

(b) (i) What was the length of the branch in shoot B on the 7th day? (1 mark)

(ii) What would be the expected length of the branch developing from shoot A on the 11th day? (1 mark)

- (c) Account for the results obtained in the experiment (6 marks)
- (d) Why was shoot C included in the experiment? (1 mark)
- (e) What is the importance of gibberallic acid in agriculture? (1 mark)
- (f) State two physiological processes that are brought about by the application of gibberellic acid on plants. (2 marks)
12. (a) State two environmental conditions that can cause seed dormancy
- (b) Name the part of a bean seed that elongates to bring about epigeal germination (1 mark)
13. (a) “True growth is not simply an increase in size” State four different ways in which true may be defined.
- (b) State two external factors, which influence growth in plants and describe one effect of each.
- (c) Fill in the spaces in the following table, which refers to hormones involved in growth processes.

Name hormone	Site of hormone production	Effect
	Thyroid gland	
		Maturation of Graafin follicles
Auxins		
Gibberellins		

14. Seedling from 100g of maize seed was grown in the dark for 10 days. The seedlings were then analyzed and compared with 100g of imbibed maize. The following results were obtained.

	Dry mass of imbibed seeds	Dry mass of seedling after 10 days
Cellulose	2g	5g
Starch	63g	9g
Other organic	13g	27g
Material Ash	2g	4g
Total dry mass	80g	45g

- (a) Why is dry mass used for comparison?
- (b) How would one ensure that the drying process had been completed
- (c) Account for the decrease in the total dry mass of the seedlings
- (d) Why did the seedling contain more cellulose than the imbibed seeds?
- (e) What is the most likely source of the carbon used to form this new cellulose?

FORM 4 WORK

CHAPTER 1

GENETICS

PAST KCSE QUESTIONS ON TOPICS

1. The figure below is a structural diagram of a portion from a nucleic acid strand.

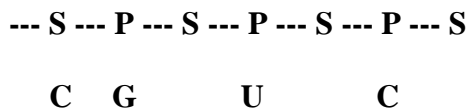

(a) Giving a reason, name the nucleic acid to which the portion belongs.

(2 marks)

Name _____

Reason _____

(b) Write down the sequence of bases of a complimentary strand to that

shown above (1 mark)

2. State two structural differences between ribonucleic acid (RNA) and deoxyribonucleic acid (DNA) (2 marks)

3. Name a disorder of human blood that is caused by mutation (1 mark)

4. State the function of deoxyribonucleic acid (DNA) molecule (1 mark)

5. Give a reason why it is only mutation in genes of gametes that influence evolution (2 marks)

6. In an experiment, red flower were crossed with plants with white flower.

All the plants in the F1 generation had pink flowers.

- (a) Give a reason for the appearance of pink flower in the F1 generation (1 mark)
- (b) If the plants from F1 generation were selfed, state the phenotype ratio of the F2 generation (2 marks)
7. State two characteristics that researchers select in breeding programmes. (2 marks)
8. Give an example of sex- linked trait in humans on; (2 marks)
- Y chromosome _____
- X chromosome _____
9. In an experiment, a variety of garden peas having a smooth seed coat was crossed with a variety with a wrinkled seed coat. All the seeds obtained in the F1 had a smooth seed coat. The F1 generation was selfed. The total number of F2 generation was 7324.
- (a) Using appropriate letter symbols, work out the genotype of the F1 generation. (4 marks)
- (b) From the information above, work out the following for the F2 generation
- (i) Genotype ratio (2 marks)
- (ii) Phenotype ratio (1 mark)
- (iii) Wrinkled number (1 mark)
10. In a certain plant species, some individual plant may have white, red or pink flower. In an experiment a plant with white parent plant were pure

lines. All the plants from F1 generation were pink. Using letter R to represent the gene for red colour and letter W for white colour;

- (a) Work out the genotype of F1 generation (3 marks)
- (b) If the plants from F1 generation were selfed, what would be the phenotypic ratio of the F2 generation? (3 marks)
- (c) What is the genetic explanation for the absence of plants with red and white in the flower F1 generation? (2 marks)

11. In a breeding experiment, plants with red flower were crossed. They produced 123 plants with red flowers and 41 with white flowers.

- (a) Identify the recessive character. Give a reason
- (b) What were the genotypes of the parent plants that give rise to the plants with red and white flowers?
- (c) If the white flowers were selfed, what would be the genotypes of their offspring?

12. (a) Name two disorders in humans caused by gene mutation (2 marks)

- (b) Describe the following chromosomal mutations
 - (i) Inversion (2 marks)
 - (ii) Translocation

(c) In mice the allele for black fur is dominant to the allele for brown fur. What percentage offspring would have brown fur from a cross between heterozygous black mice and brown mice? Show

your working. Use letter B to represent the allele for black colour.

(4 marks)

13. (a) What is meant by the term allele? (1 mark)
- (b) Explain how the following occur during gene mutation
- (i) Deletion (1 mark)
- (ii) Inversion (1 mark)
- (c) What is a test- cross? (1 mark)
14. In maize the gene for purple colour is dominant to the gene for white colour. A pure breeding maize plant with purple grains was crossed with a heterozygous plant.
- (a) (i) Using letter G to represent the gene for purple colour, work out the genotypic ratio of the offspring (5 marks)
- (ii) State the phenotype of the offspring (1 mark)
- (b) What is genetic engineering? (1 mark)
15. Define the following terms as used in genetics.
- (i) Alleles
- (ii) Genotype
- (iii) Phenotype
16. A farmer mated his dark red cow with a white bull. The cow gave birth to a light red calf
- (a) State why the calf is light red and not dark red or white

- (b) If a light red bull is mated with a dark red cow, work out using appropriate letter symbols the probability of getting a light offspring
17. (a) What is meant by linked genes?
- (b) (i) In fruit flies (*Drosophila*) the gene for red eyes (R) is dominant over the one for white – eye (r). If a true breeding white – eyed male, all the offspring will be red eyed. However, if a true – breeding white-eyed female is mated with a true- breeding red- eyed male, all the female offspring will be red – eyed. Explain this apparent contradiction.
- (ii) Work out the ratio of the expected phenotypes if a red- eyed female offspring from the cross- described in (i) above is mated with red- eyed males.
18. (a) Explain the term variation with reference to the study of genetics.
- (b) Using relevant examples distinguish between discontinuous variation and continuous variation
- (c) What is the importance of genetic variation?
- (d) Describe one example where genetic variations has helped a species to survive
19. The diagram below shows the base sequence of part of a nucleic acid strand. Observe it and answer the questions that follow
- G T T A G C T G A
- (a) What do the letters G, T, C and A represent?

- (b) Giving your reasons state whether it is part of DNA or an RNA strand.
 - (c) Show the complementary DNA strand
 - (d) Show the complimentary RNA strand
20. In human couples the sex of a baby is determined by the man. Explain this statement.

CHAPTER 2

EVOLUTION

PAST KCSE QUESTIONS ON TOPICS

1. State the difference between Lamarckian and Darwinian theories of evolution
2. Two populations of the same species of birds were separated over a long period of time by an ocean. Both populations initially fed on insects only. Later it was observed that one population fed entirely on fruits and seeds. Although insect were available. Name this type of evolutionary change.
3. Explain why Lamarck's theory of evolution is not accepted by biologists today
4. State three pieces of evidence that support the theory of evolution. (3 marks)
5. state two advantages of natural selection to organisms (2 marks)
6. Give a reason why each of the following is important in the study of evolution
 - (i) Fossils records
 - (ii) Comparative anatomy
7. Describe how natural selection brings about adaptation of a species to its environment (6 marks)
8. Explain how the process of evolution may result to the formation of new species
9. What is meant by
 - (a) organic evolution (1 mark)
 - (b) continental drift (1 mark)
10. Explain continental drift as an evidence of evolution (3 marks)
11. (a) What is a test- cross? (2 marks)

(b) Give a reason why organisms become resistant to drugs (1 mark)

12. Distinguish between the following terms

(a) Homologous structures

(b) Analogous structures (4 marks)

13. (a) What is meant by natural selection?

(b) Explain the role played by mutation in evolution (5 marks)

14. Define the following terms

(a) Hybrid

(b) Hybrid vigour

15. The peppered moth exists in two varieties, which are genetically controlled. The dark variety is found predominantly in industrial cities and the white variety is found predominantly in rural areas. Explain how this pattern of distribution supports the theory of evolution by natural selection (6 marks)

16. Explain what is meant by the following concepts

(a) Special creation (2 marks)

(b) Organic evolution (2 marks)

CHAPTER 3

RECEPTION, RESPONSE AND CO-ORDINATION

PAST KCSE QUESTIONS ON THE TOPIC

1. State one structural and one functional differences between motor and sensory neurons

Structural differences

Functional differences

(2 marks)

2. The table below shows two mammalian hormones. For each hormone, state the site of production and its function in the body.

Hormone	Site of production	Function
Oestrogen		
Aldosterone		

- 3.

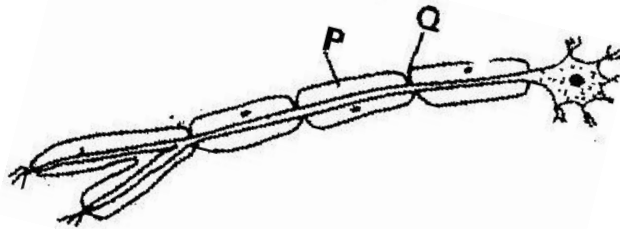

- (i) With an arrow, indicate on the diagram the direction of the impulse through the neurone (1 mark)
- (ii) State the functions of parts labeled P and Q (2 marks)

4. (a) How are structures of the human eye adapted to their functions (14 marks)
- (b) State three defects of the eye and how each can be corrected (6 marks)
5. State the changes that occur in a nerve axon to produce an action potential (3 marks)
6. In an accident a victim suffered brain injury. Consequently he had loss of memory. Which part of the brain was damaged? (1 mark)
7. The diagram below shows surface view of a human brain

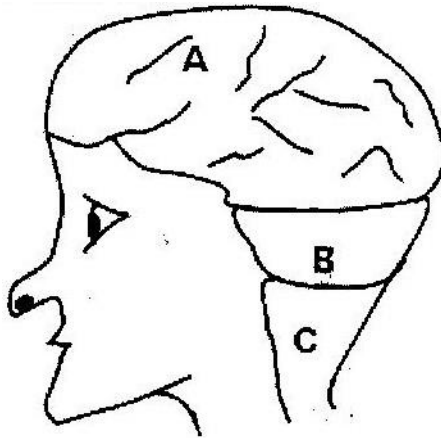

- (a) Name the parts labeled B and C (2 marks)
- (b) State three functions of the part labeled A (3 marks)
- (c) State what would happen if the part labeled B was damaged. (1 mark)
8. What is the function of the following cells in the retina of the human eye? (2 marks)
- (a) Cones
- (b) Rods
9. (a) State the functions of the following parts of the mammalian ear (3 marks)
- (i) Tympanic membrane

(ii) Eustachian tube (1 mark)

(iii) Ear ossicles (2 marks)

(b) Describe how semi- circular canals perform their functions (2 marks)

10. State the importance of tactic response among some members of Kingdom

Protista? (1 mark)

(a) What name is given to response to contact with surface exhibited by tendrils and climbing stems in plants? (1 mark)

(b) State three biological importances of tropisms to plants (3 marks)

11. The diagram below represents a reflex arc in human

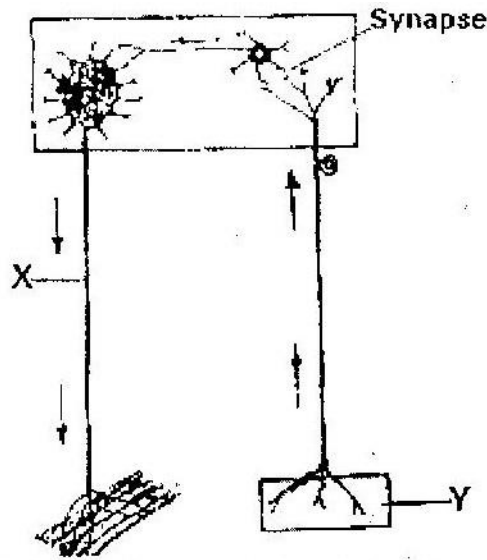

(a) Name the parts labeled X and Y (2 marks)

X _____

Y _____

(b) Name the substance that is responsible for the transmission of an impulse across the synapse (1 mark)

12. (a) State the function of the ciliary muscles in the human eye. (1 mark)
- (b) State two functional differences between the rods and cones in the human eye (2 marks)
13. State the function of each of the following parts of human ear (4 marks)
- (a) Ear ossicles
 - (b) Cochlea
 - (c) Semi- circular canals
 - (d) Eustachian tube
14. (a) Where in the human body are relay neurons found? (1 mark)
- (b) The diagram below represents a neurone

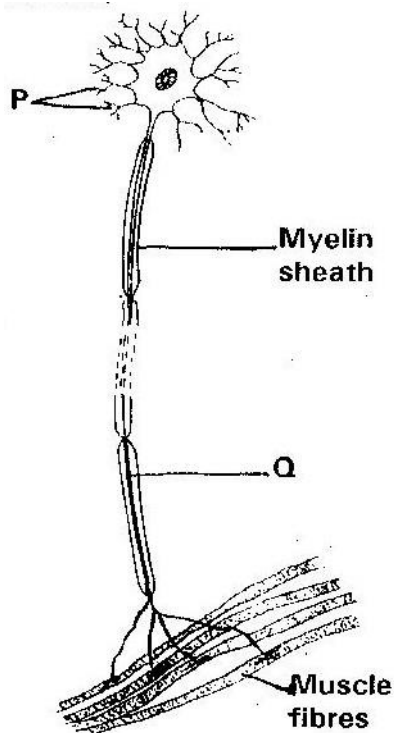

- (i) Name the neurone (1 mark)
- (ii) Name the parts labeled P and Q (2 marks)
15. (a) Name the hormone that is responsible for apical dominance (1 mark)
- (b) What is thigmotropism? (1 mark)
16. Describe the structure and functions of the various parts of the human ear (20 marks)
17. Nocturnal animals such as the owl are capable of seeing fairly well at night
What two retinal adaptations have made this possible? (2 marks)
18. State two functions of the human ear? (2 marks)
19. State four differences between co-ordination of the human eye's internal response to light and that of tropic movement of the flowering plant in response to light. (4 marks)

20. The figure below shows a stem of a plant growing round a tree trunk

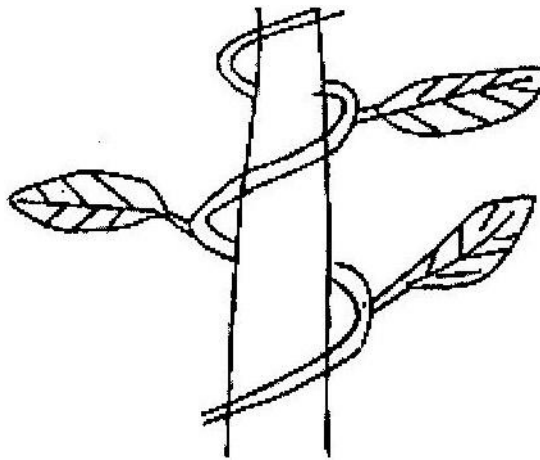

- (i) What is the name of the response, which causes the twisted growth? (1 mark)
- (ii) Explain how the twisting process is accomplished (2 marks)
- (iii) Identify the state of leaves if the plant is autotrophic (2 marks)
21. Euglena is positively phototactic. Of what biological significance is this characteristics? (1 mark)
22. State the function of acetylcholine (2 marks)
23. Where in the human body is the relay neurone located? (1 mark)
24. State three effects of nicotine to human health (3 marks)
25. state the part of the eye involved in
- (i) Colour vision
- (ii) Maintaining shape of the eyeball
- (iii) Change in diameter of the lens

CHAPTER 4

SUPPORT AND MOVEMENT IN PLANTS AND ANIMALS

PAST KCSE QUESTION ON THE TOPIC

1. The diagram below represents in a mammalian bone

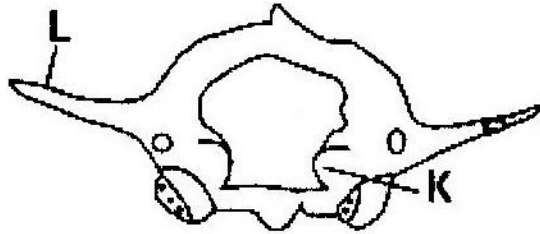

- (a) State the function of the part labeled K and L (2 marks)
- (b) State the region of the body in which the bone is found (1 mark)
2. State two ways in which skeletal muscle fibres are adapted to the function (2 marks)
3. The diagram below shows the arrangement of bones and muscles in a human arm.

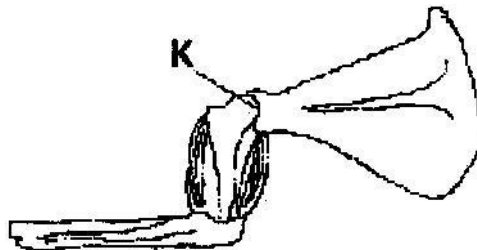

- (i) Name the parts of the bone labeled K (1 mark)
- (ii) How do the muscles work to extend the arm? (3 marks)
4. State three structural differences between biceps muscles and muscles of the gut

	Biceps	Gut muscles
(i)		
(ii)		
(iii)		
(iv)		

5.



- (a) Name the bone (1 mark)
- (b) Name the type of joint formed by the bone at its anterior end with the adjacent bone (1 mark)
6. Give a reason why the lumbar vertebrae have long and abroad transverse processes (2 marks)
7. (a) Name the three types of skeletons found in multicellular animals (3 marks)
- (b) Describe how the cervical, lumbar and sacral vertebrae are suited to their functions (17 marks)
8. A bone obtained from a mammal is represented by the diagram below



- (a) Name the bone (1 mark)
- (b) Which bones articulate with the bone shown in the diagram at the notch? (2 marks)

9. (a) Name the cartilage between the bones of the vertebral column (1 mark)]

- (b) State the function of the cartilage in (a) above (1 mark)

10. How are xylem vessels adapted for support? (1 mark)

11. The diagram below represents bones at a joint found in the hind limb of a mammal

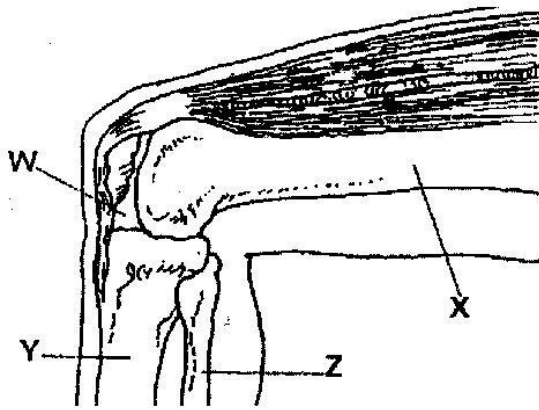

- (a) Name the bones labeled X, Y, and Z (3 marks)

X _____

Y _____

Z _____

- (b) (i) Name the substance found in the place labeled W (1 mark)

- (ii) State the function of the substance named in (b) (i) above

- (c) Name the structure that joins the bones together at the joint (1 mark)

- (d) State the differences between ball and socket joint and the one illustrated in the diagram above (1 mark)
- (e) Name the structure at the elbow that performs the same functions as the patella (1 mark)
12. (a) State a characteristic that is common to all cervical vertebrae
- (b) Name two tissues in plants that provide mechanical support (2 marks)
13. (a) Name the three types of muscles found in mammals and give an example of where each one of them is found
- (b) State the difference between ball and socket and hinge joint (1 mark)
14. State three functions of an insect's exoskeleton (3 marks)
15. State the function of the following fins of a fish
- (a) Dorsal fin (1 mark)
- (b) Pectoral and pelvic fins (1 mark)
- (c) Caudal fin (1 mark)
16. State the diagnostic features of the cardiac muscles (3 marks)

The following figure is a part of a pelvic girdle known as the innominate bone



- (a) Make a complete drawing of the girdle (1 mark)
- (b) Name the bones that articulate with the pelvic girdle. In each case name the part that articulates with (2 marks)
17. Distinguish between tendons and ligaments (2 marks)
18. Explain what antagonistic muscles are and give an example (4 marks)
19. (a) Name three types of strengthening tissues found in plants (3 marks)
- (b) Explain how the tissue in (a) above are adapted to their functions (3 marks)
20. (a) Name the three main types of joint (3 marks)
- (b) Give an example of where each type of joint name in (a) above is found in the human body (3 marks)
21. What makes young herbaceous plant remain upright? (2 marks]
22. Name three types of muscles found in the human body, state where each type is located and how each is adapted to its functions. (12 marks)

KCSE SAMPLE PAPERS

KCSE SAMPLE PAPER 1

TOTAL MARKS: 80

Answer all questions

1. Name the structures used for locomotion in each of the following organism
 - (a) Euglena (1 mark)
 - (b) Paramecium (1 mark)
2. (a) What is sex - linkage? (2 marks)
 - (b) Name one sex- linked trait in human beings (1 mark)
3. Blackjack (*bidens pilosa*) belongs to the family *compositae*. What is the plants
 - (a) Genus (1 mark)
 - (b) Species (1 mark)
4. Name two metabolic waste products in
 - (a) Birds (2 mark)
 - (b) Plants (2 marks)
5. State the adaptations of seed to dispersal by wind (3 marks)
6. State the importance of the growth of pollen tubes in flowering plants (1 mark)
7. State three structural differences between DNA and RNA in living cells (3 marks)
8. (a) State two differences between meiosis and mitosis (2 marks)
 - (b) State two processes that takes place during interphase (2 marks)

9. Name two parts in the human body with cilia (2 marks)

10. The diagram below represents a closed stoma



(a) Identify the cells labeled A and B (2 marks)

(b) Name the excretory product in plants which is excreted through the stomata

(1 mark)

(c) State one adaptation of the guard cell to its function

(1 mark)

11. Name two organisms that form the biological environment of a malaria parasite

(2 marks)

12. Name the organs of the mammalian body that are responsible for production of gametes (2 marks)

13. List three adaptations of fruits that are dispersed by animals (3 marks)

14. The equation below show what happens in cellular respiration



(a) Name the type of respiration shown and where it occurs in a cell

(2 marks)

(b) Determine the respiratory quotient of the process

(2 marks)

(c) What food substrate is broken in the respiration?

(1 mark)

15. List two features of the small intestine that increase its surface area

(2 marks)

16.

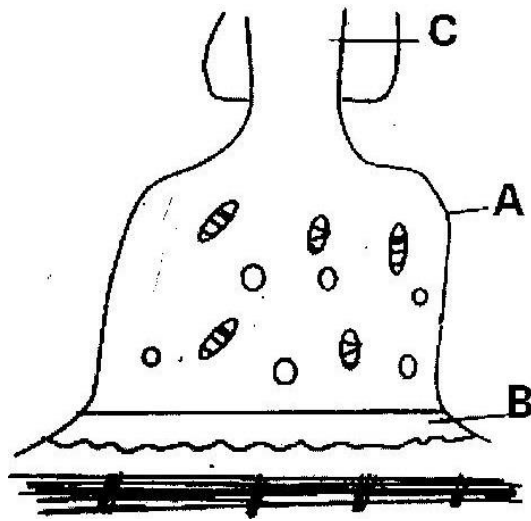

The diagram above shows synapse at a neuromuscular junction

- (a) Name the parts labeled A and B
- (b) State the function of the part labeled C

17. Explain why food is stored in an insoluble form in the cells of living things

(2 marks)

18. State the observation made in germinating seeds when the

- (a) Hypocotyle elongates
- (b) Epicotyle elongates

19. State the differences between assimilation and absorption of food nutrients

(2 marks)

20. State three homeostatic function of the liver

21. Differentiate between lactic fermentation and alcoholic fermentation

(4 marks)

22. Water logging can cause the death of some plants. Explain (2 marks)

23. Distinguish between plasmolysis and haemolysis (2 marks)
24. John and grace who are siblings are both normal and so are their parents but they have a haemophilic brother. Give the genotypes of their parents. (2 marks)
25. The diagram below shows a section of a dicotyledonous stem.

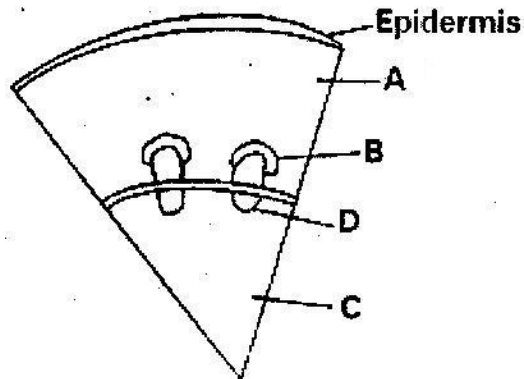

Name the tissues labeled A and D and state the function of each.

26. Name the organism that causes each of the following diseases

- (a) AIDS
- (b) Bilhazia
- (c) Cholera (3 marks)

27. List three examples of gaseous exchanges surfaces in animals (3 marks)

28. state the significance of photosynthesis (3 marks)

29. Explain the meaning of each of the following

- (a) Continental drift
- (b) Fossils (2 marks)

30. Green plants grow towards a source of light

Name this type of response (1 mark)

KCSE SAMPLE PAPER 2

TIME 1 ¾ HOURS

This paper consists A and B. Answer ALL the question in section A in the spaces provided. In Section B answer question 6 (compulsory) and either question 7 or 8 in the spaces provided.

SECTION A (40 MARKS)

Answer all the questions in this section

1. (a) What is gene linkage (1 mark)
- (b) Haemophilia is sex linked trait
- (i) If a normal woman but a carrier for haemophilia marries a normal man work out the phenotype of the offspring using a genetic cross. (5 marks)
- (ii) Why is haemophilia, more common defect in males than in females? (1 mark)
- (iii) Other than haemophilia state any other sex linked defect in man (1 mark)
2. The table below shows the percentage composition by volume of inhaled and exhaled air

Gas	Inhales air %	Exhales air %
Oxygen	21	16
Carbon (IV) Oxide	0.04	4.0
Nitrogen	79	79

- (a) (i) By what percentage is the carbon (IV) Oxide concentration in exhaled air higher than inhaled air? (3 marks)
- (ii) Explain the differences in the composition of the gases between inhaled and exhaled air. (3 marks)

(b) State two ways in which leaves of plant are adapted for gaseous exchange?

(2 marks)

3. The chart below represents the flow of nitrogen in the ecosystem

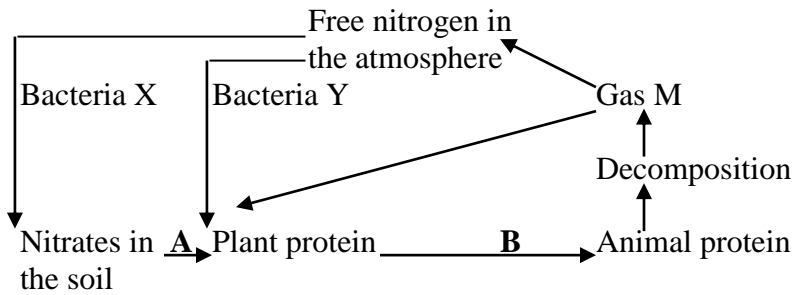

(a) Name the bacteria labeled X and Y



(2 marks)

(b) Name the gas M

(c) Name processes A, B and C

(d) State the bacteria involved in the process named C

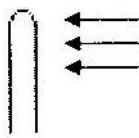
4. An experiment was set up to investigate the effect of unilateral light in growth of maize seedlings. The diagram in the table below represents experimental set up at the beginning.

Experimental set up	Beginning of experiment	Expected results
C		
D		
B		

- (a) Using diagrams complete the table to show the expected results in experimental set up. (3 marks)
- (b) Account for your results in experimental set up (3 marks)
- (c) Explain the purpose of experimental set up B and C (2 marks)
5. (a) What is internal fertilization? (1 mark)
- (b) Suggest two disadvantages of internal fertilization in most mammals (2 marks)

- (c) State two roles of placenta in mammals (2 marks)
- (d) Mention one role played by each of the following hormones in human menstrual cycle
- (i) Follicle stimulating hormones (FSH)
 - (ii) Oestrogen
 - (iii) Luteinizing Hormone (LH)

SECTION B (40 MARKS)

Answer question (compulsory) in the spaces provided either question 7 & 8 in the spaces provided after question 8.

6. The following data are results of making daily growth measurement ion an organism over a period of 24 days during its development.

Day	Width of head (mm)	Length of hind femur (mm)
1.	3.0	7.0
2.	3.5	7.5
3.	4.0	8.0
4.	4.0	8.0
5.	4.0	8.0
6.	4.0	9.2
7.	4.0	10.5
8.	4.4	12.0
9.	4.7	12.0
10.	5.0	12.0
11.	5.0	12.0
12.	5.0	12.0
13.	5.0	12.0
14.	5.0	12.0
15.	5.0	13.3
16.	5.0	14.8
17.	5.7	16.4
18.	6.4	18.0
19.	7.0	18.0
20.	7.6	18.0
21.	7.6	18.0
22.	7.6	18.0
23.	7.6	18.0
24.	7.6	18.0

- (a) Using a suitable scale draw graphs of width of head and length of femur against time.
Draw the graphs on the same axis. (8 marks)
- (b) (i) Name the growth pattern represented by the graph (1 mark)
(ii) With reference to your graph identify the phylum to which the organisms belong. Give a reason for your answer (2 marks)
- (c) Account for the length of hind femur between
(i) Day 3 and day 7 (3 marks)
(ii) Day 7 and day 10 (2 marks)
- (d) State two hormones involved in the growth pattern represented by the graphs (2 marks)
- (e) State two advantages of metamorphosis in organisms (2 marks)
7. Describe how water and mineral salts move from soil until they reach the leaves in a tall plant. (20 marks)
8. (a) Describe the following terms:
(i) Secretion
(ii) Excretion
(iii) Egestion (3 marks)
- (c) Explain how the mammalian kidney is adapted to its functions. (17 marks)

KCSE SAMPLE PAPER 3

(PRACTICAL)

(TOTAL MARKS 40)

You are provided with specimen

A. Onion bulb

B. Cockroach

- Iodine solution
- Benedict's solution
- Means of heating
- Hind legs

1. Make a longitudinal section through specimen A

- (a) Make a labeled diagram of the specimen (3 marks)
- (b) (i) Using a pestle and a mortar, crush some leaves of one half of the specimen. Using the reagents provided tests for food substances present in extract. Record your finding in the following table.

Food	Procedure	Results	Conclusion

- (ii) Account for the result in (b) (i)

(c) (i) Cut six leafstalks into 4 cm long pieces make a slit 2 cm long at one end of each of the stalks. Immerse the stalks into tube- tubes with the following liquids.

- Distilled water
- 20% salt solution
- Extract obtained in (b) above

Leave the set – up for 30 minutes. Account for the result.

(ii) Of what significance are the results obtained in distilled water?

(d) How do the part of the plant adapt to its way of life? (2 marks)

2. Study specimens below and answer the questions that follow

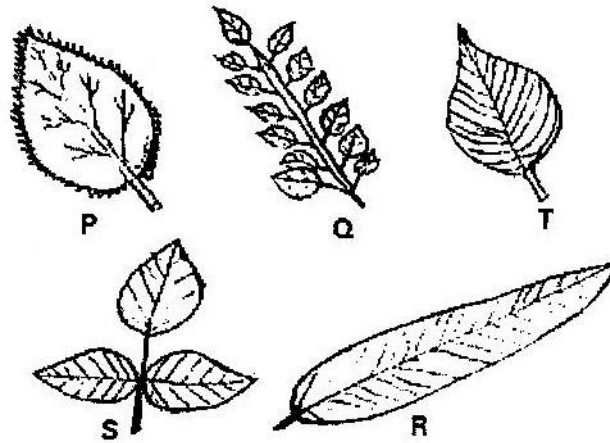

A dichotomous key was constructed identify the plant leaves as follows

1. (a) Simple leaf.....Go to 2
- (b) Compound leafGo to 4

2. (a) Leaf has serrated marginHibiscus
- (b) Leaf has smooth marginGo to 3

3. (a) Leaf has smooth marginMango
 (b) Leaf is ovateMorning glory
4. (a) Leaf has many leafletsNandi Flame
 (b) Leaf has 3 leaflets.....Bean

Identify steps followed for each of the leaves and state its identity

Leaf	Steps followed	Identity
P		
Q		
R		
S		
T		

3. Using the hand lens to study specimen B.
- (a) Identify the Phylum and class of which the specimen belongs. Give two reasons for each.
- Phylum _____
- Reasons
- (i)
- (ii)

Class _____

(i)

(ii)

- (b) Draw a well labeled diagram of specimen B (3 marks)
- (c) State three difference between specimen B and man (2 marks)
- (d) How is specimen B adapted to living between cracks (2 marks)

KCSE SAMPLE PAPER 231/3

(PRACTICAL)

1. You are provided with specimens labeled J1, J2, K1 and K2. Examine them.

J1 – Bean seedling with a curved end

J2 – Bean seedling with straightened end

K1 – maize seedling with coleoptile intact

K2 - Maize seedling with first foliage leaves

(a) With a reason name the order to which specimens J1 and J2 and K1 and K2

belong (4 marks)

J1 and J2 _____

Reasons _____

K1 and K2 _____

Reasons _____

(b) (i) Name the curved part of specimens J1 (1 mark)

(ii) What is the importance of curvature? (1 mark)

(c) Explain how the curved part in J1 will straighten so that the stem will look like

that of J2 (4 marks)

(d) Name the part that protects the plumule in specimen K1 and K2(1 mark)

(e) (i) Which of the two types of seedlings may form swelling on the roots later

in its life?

(ii) What is the name of the swellings? (1 mark)

- (iii) Name the organisms that would be found in the swellings (1 mark)
- (iv) Explain the relationship that exists between the named organisms and the plant. (3 marks)
- (f) (i) Name the structures found on the stem just below the leaves of specimen J2. (1 mark)
- (ii) State two functions of the structure named in (f) (i) above (2 marks)
- (g) (i) State the type of germination exhibited by specimen K1 and K2 (1 mark)
- (ii) Give a reason for your answer in (g) (i) above (1 mark)
- (h) Name the root system found in specimens
 - J1 and J2 (1 mark)
 - K1 and K2 (1 mark)

2. You are provided with specimens labeled M and N which were obtained from an animal. Examine them.

M - Trachea (part of trachea)

N - Part of lung

- (a) Identify the specimen of (2 marks)

Identity of M _____

Identity of N _____

- (b) Name the part of the body from where each of the specimens was obtained.

Specimen M _____

Specimen N _____

(c) What is the relationship between specimen M and N terms of their functions. (2 marks)

(d) For each specimen name observable feature and state how each feature adapts the specimen to its function? (10 marks)

Specimen	Feature	How feature adapts to its function
M		
N		

3. You are provided with specimen labeled Q and R. Examine them

Q - Lumbar vertebrae

R - Cervical vertebrae

Both obtained from the same mammal

(a) Identify the specimens and each case give two reasons for your answer.

(6 marks)

(i) Specimen Q _____

Reason 1 _____

2 _____

(ii) Specimen R _____

Reason 1 _____

2 _____

(b) State four ways in which specimen R is adapted to its functions

(4 marks)

(c) State four differences between specimens Q and R (4 marks)

(d) Draw and label the anterior view of specimen R

BIOLOGY PAPER 3

1. The photographs below are of bones obtained from the same region of a mammalian body. Photographs labeled K are different views of the same bone while M and N are views of different bones.

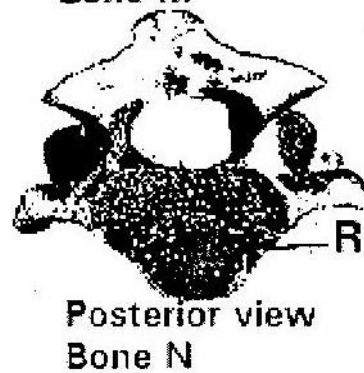
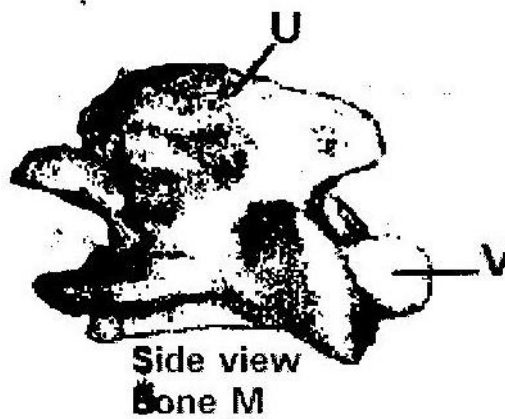
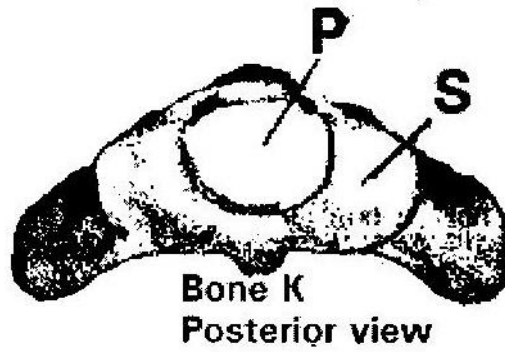
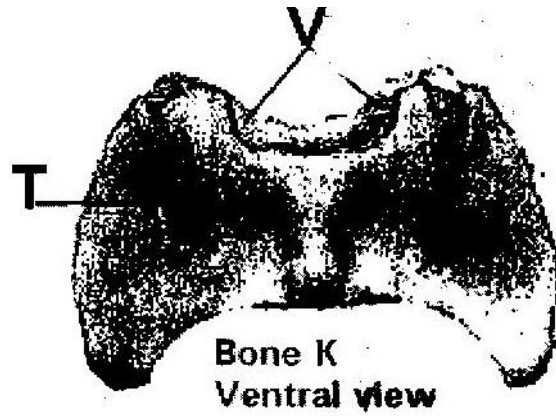

(a) Name the region from which the bones were obtained (1 mark)

(b) Identify the bones (3 marks)

K _____

M _____

N _____

(c) State three characteristics features of the bone on photographs labeled K.

(3 marks)

(d) Name the structures that fit in the opening labeled P in the photographs of bone K.

(2 marks)

(e) State the functions of the parts labeled S and T in photographs of bone K

(2 marks)

S _____

T _____

(f) Name the structures that articulate with the parts labeled V in the photographs of bone K. (1 mark)

(g) Name the parts labeled U and V in the photograph of bone M and R in the photograph of bone N (3 marks)

U _____

Y _____

R _____

2. You are provided with two pieces of plant material labeled specimen D. Using a scalpel cut a slit halfway through the middle of each piece as shown in the diagram below.

Place one piece in the solution labeled L₁ and the other in the solution labeled.

Allow the set up to stand for 30 minutes.

- (a) After 30 minutes remove the pieces and press each gently between the fingers.

- (i) Record your observations

L₁ _____ (1 mark)

L₂ _____ (1 mark)

- (ii) Account for the observation in (a) (i) above (2 marks)

3. You are provided with three sets of seedlings labeled A, B and C. Examine them.

- (a) State the conditions under which each set was grown (3 marks)

Set A _____

Set B _____

Set C _____

- (b) State four differences between the seedlings in set A and B (4 marks)

- (c) (i) Give a reason why plants exhibit the phenomena named in (c) (i) above

(1 mark)

- (d) (Name the response exhibited by the seedling in set C. (1 mark)

- (e) Explain how the response named in (d) above occurred (3 marks)

ANSWERS TO TOPICAL QUESTIONS

FORM 1 WORK

CHAPTER 1 – INTRODUCTION TO BIOLOGY

1.

Plants	Animals
- Manufacture their own food	- Cannot manufacture their own food
- Grow continuously throughout their life	- Stop growing when they reach maturity
- Slow in responding to stimuli	- Fast in responding to stimuli

- 2.
- Growth of the organism
 - Movement of the organism
 - Maintenance of metabolic activities

- 3.
- They grow
- They respire
 - They have gaseous exchange
 - They reproduce
 - They excrete
 - They respond to stimuli
 - They have nutrition

- 4.
- They reproduce
- They grow
- They respond to stimuli

CHAPTER 2- CLASSIFICATION 1

1.

- (a) Binomial nomenclature is a system of naming organisms by giving them two scientific names, the generic and the specific names.
- (b)
 - It makes it easier to identify an organism.
 - It is easier to describe an organism as it is based on characteristics of the organism
 - Large number of organisms are divided into smaller groups depending on characteristics
 - The whole world uses the same groupings, so everyone understands each other.

2.

- (a) Classification – placing of animals and plants into group according to their similarities in structure, physiological processes and ancestry.
- (b) Taxonomy - scientific study of classification.
- (c) Binomial nomenclature- system of naming using two names. The first part of the name represents the genus (generic name) while the second part refers to species or is the specific name.

3.

- (a)
 - Nucleus not organized
 - Organelles not bound by membrane
 - Absence of mitochondria
- (b) Class insecta

4.

Genus

5. Specific name
6. Species – A species is the smallest unit of individual organisms which has hereditary distinction from that of any other group and whose members naturally interbreed to produce fertile offspring
7. Taxonomy- Scientific study of classification
8. Taxon- Each group of classification

CHAPTER 3 – THE CELL

1. (a) - Secretion of useful substances
- Formation of secretory vesicles
2. (a) - Destroying old and worn out organelles
(b) - Secretion reticulum (rough)
- Formation of secretory vesicles
3. (a) - Mitochondrion
(b) - Chloroplast
4. - Ribosomes
- Endoplasmic reticulum (rough)
5. (a) - X- chloroplasts
- Y - Vacuole
(b) In dim light. They move to the upper part of the cell in order to receive enough sunlight for photosynthesis
6. (a) - Increase surface area for attachment of respiratory enzymes hence increasing rate of respiration.

- (b) (i) Stroma
 - (ii) Absorb sunlight used for light stage of photosynthesis
7. (a) $\text{Drawing} = \frac{\text{Length of the drawing}}{\text{Length of the object}}$
Magnification
- (b) It is adding a dye to the specimen to make the features clearer and distinguishable
8. - Form vesicles that transport materials to other parts of the cell e.g. proteins
- Transport secretions to the cell surface for secretion e.g. enzymes and mucus.
- They form lysosomes
9. - Cell wall
- Large vacuole
- Chloroplast
- Starch granules
10. (i) Reflect light from the source to the microscope/specimen
(ii) Regulate amount of light entering the microscope/reaching specimen.
(iii) Move body tube up and down in order to obtain a rough focus of the image of specimen.
11. It is the ability to differentiate two structures or organelles lying close
12. (a) A cell is structurally and physiologically modified in order to perform a

particular function.

- (b) (i) Presence of dendrites to receive impulses
- (ii) Presence of chloroplasts to trap sunlight
- (iii) Elongated and no cuticles in order to absorb water
- (iv) Biconcave shape to increase surface area for diffusion of oxygen/haemoglobin.

$$13. 1 \text{ mm} = 1000\mu\text{m}$$

$$3.5 \text{ mm} = 3500 \mu\text{m}$$

$$10 \text{ cells} = 3500 \mu\text{m}$$

$$1 \text{ cell} = \frac{3500}{10} \mu\text{m}$$

$$10$$

$$1 \text{ cell} = 350 \mu\text{m}$$

- 14. (i) Made of several specialized cells grouped together and perform particular function.
- (ii) Made of a group of specialized tissues grouped together performing a particular function
- (iii) It is made of several organs that perform a particular function.

CHAPTER 4

CELL PHYSIOLOGY

1.
 - a)
 - i) Diffusion
 - ii) Active transport
 - b) Diffusion-A concentration gradient between sodium ions in sap and those in the pond.

Active transport-energy in form of ATP must be available/Oxygen and food in the living tissue for respiration provide energy.
2. A film of water surrounds the soil particle. Root hairs of the plants penetrate between the soils particles/are close to the soil particles; cell sap of the root hair cells is more concentrated in solutes/has less water than the soil solution. Thus water moves into root hair cell by osmosis i.e across the cell a wall and the semi permeable membrane.
3. The leaves expose a smaller surface area to the sun. Thus reducing transpiration/excessive water loss.
4.
 - a) Diffusion is defined as the net movement of a substance from a region where its concentration is high to a region where its concentration is low.
 - b)
 - i) Diffusion gradient-the greater the diffusion gradient, the greater the rate of diffusion
 - ii) Surface area to volume ratio-the greater the S.A.V.R the higher the temperature the greater the rate of diffusion.
 - iii) Temperature –The higher the temperature the greater the

rate of diffusion

- c)
 - i) Absorption of mineral salts from the soil by root hairs
 - ii) Re-absorption of glucose molecules in the kidney tubule.
 - iii) Absorption of digested food in the ileum e.g glucose, amino acids.
- 5.
 - i) Uptake of water from the soil into root hairs of plant roots
 - ii) Movement of water from the veins of leaves through the leaf cells to the atmosphere during transpiration.
- 6.
 - a) The visking tubing was fully filled with solution. Level of water in beaker decreased .
 - b) Sucrose solution in visking tubing created high concentration gradient.
 - Water molecules moved from distilled water to the visking tubing by osmosis.
- 7. -Plant cells have cells membrane and cell wall. When the cell is placed or immersed in distilled water, the water is absorbed by osmosis. As cell becomes turgid, the cell created an inward force, wall pressure that prevents the cell from bursting.

8.

Diffusion	Osmosis
<ul style="list-style-type: none">• Involves movement of particles of molecules of liquid or gas.• It may be through a membrane or in air.• Not affected by PH changes.	<ul style="list-style-type: none">• Involves movement of solvent• It takes place through a semi-permeable.• Rate affected by pH changes.

9. a) Isotonic solution- a solution which has the same concentration as the cell sap.
- b) Hypotonic solution- a solution which is less concentrated than the cell sap.
- c) Hypertonic solution- A solution which is more concentrated than the cell sap.
10. Plants normally grow in soils whose solute concentration is lower than that of the cell sap. This enables the plants to take up water by osmosis. Addition of large amounts of salt to the soil increases the solute concentration of soil water beyond that of the cell sap. The result is that the plants lose water to the soil by osmosis. Since water is very important for maintaining the structural and metabolic activities of plants, its deficiency leads to death of the plants.
11. a) The red blood cells take in water by osmosis. They swell and

exert pressure on the fragile plasma membrane which then breaks. Plant cells take in water and swell but do not burst. This is because their tough cell wall can only stretch to a limited extent. Once fully stretched, the cell wall resists further expansion of the cell and no more water is taken up.

- b) Fresh water protozoa take in water by osmosis. The excess water is then actively pumped into the contractile vacuole which discharges the water to the outside.

CHAPTER -5

NUTRITION IN PLANTS

1.
 - a) K- Enzyme , sucrose, invertase
L- Inhibitor
 - b) Additional of sucrose/substance, Addition of enzyme, Optimum PH, Removal of products.
 - c) Complete with substrate for active site of the enzyme.
2.
 - a) Split water molecules/photolysis
 - b) Glucose
3. Yellowing of leaves/stunted growth/chlorosis/lack of chlorophyll.
4.
 - a)
 - i) A and B -more active sites of enzymes available for a large number of molecules of substrate. There is increase in rates of reaction
 - ii) B-C
- Enzyme/substance are in equilibrium. All active sites are occupied hence rate of reaction is constant.
 - b) Raising concentration of enzymes
 - c) PH, temperature, inhibitors/cofactors.
5.
 - a) Substances that activate enzymes
 - b) Iron/Magnesium/Zinc/Copper.
6.
 - Magnesium,
 - Nitrogen
 - Iron

7. Xylem

- Transport water to photosynthesizing cells from stem
- Offer support to the lamina for maximum exposure to sun-light.

Phloem

- Transport manufactured food away from the leaf to create high concentration gradient.

8. Takes place in the grana of the chloroplast. Light is absorbed and used to split water molecules into hydrogen ions and oxygen, photolysis. Energy is formed and is stored in form of ATP.

9. a) i) Light stage-grana

ii) Dark stage-stroma

b) -Uses the energy formed or produced during light stage.

-Uses the hydrogen ions produced in light stage for carbon dioxide fixation.

10. i) Cuticle-Transparent allowing light to penetrate.

ii) Veins -Xylem vessel transport water to the photosynthesizing cells as it is a raw material

Phloem - Transport manufactured food out of the leaf to create high concentration gradient.

11. a) To hydrolyse/break down the disaccharide (non-reducing sugar).

b) Non-reducing sugar

c) i) Condensation,

ii) Hydrolysis

- d)
 - i) Starch,
 - ii) Glycogen
- 12.
 - i) Fatty acids and glycerol
 - ii) Form part of the cell membrane
 - Provide insulation of bodies of animals
 - A source of metabolic water.
 - Provide energy in absence of carbohydrates
- 13.
 - a)
 - L - Blue-black
 - M -Yellow
 - N - Blue Black
 - b) Absorb carbon (IV) oxide in the jar.

CHAPTER 6

NUTRITION IN ANIMALS

1. a) Rhizobium
 b) Symbiosis
2. a) Activate enzymes
 b) Magnesium/zinc
3. Scuvy
4. - Rickets
 - Goitre
5. Sharp/ hooked/ strong beaks for killing/ripping off flesh from bones, sharp claws for grabbing/holding prey.
6. i) Salting -This removes / absorbs water by osmosis from micro-organism cell. Which then die due to dehydration. Meat also becomes dehydrated and thus unsuitable for microbial growth.

 ii) Refrigeration –Low temperature renders the micro-organism inactive (Enzymes do not work at low temperature).

 iii) Canning –Boiling kills all micro-organism in the food. Sealing under pressure excludes all micro-organisms and ensures that growth takes place.
7. Similarity: Both are heterotrophic.
 Difference: Predators kill to get food while parasites obtain foods without killing the host.

8. Pancreatic juice containing digestive enzymes is prevented from reaching food.
Insulin and glycogen hormones which regulate sugar are released directly into the blood stream.
9. Roughage provide grip needed for peristalsis/lack of roughage results in slow/no movement of food leading to constipation. (Accept: add bulk to peristalsis to take place)
10. a) Breakdown of (complex) food substance by enzymes to simpler compounds which can be absorbed.
b) - Small intestine is long/coiled to offer large surface area for digestion and absorption.
- The walls are muscular for peristalsis.
- Inner walls posses mucus glands, goblet cell; that secret mucus for lubrication and protection of the walls from digestive enzymes.
- The inner walls have digestive glands that secrete digestives enzymes.
- The inner walls has villi to increase surface area for absorption.
- The villi have numerous blood vessels for transport of the end products of digestion.
- The villi also have lacteal vessels, for transport of fats/lipids.
11. - Quicken healing of wounds
- Forms connective tissues of the teeth and jaws.
- Provides resistance to body infections
12. a) Homodont-Organism has same number of teeth, type of teeth and the same

size.

- b) Slice fish and crush bones
 - c) $I = \frac{0}{3}$, $C = \frac{0}{3}$, $PM = \frac{3}{3}$, $M = \frac{3}{3}$
- 13.
- a) -Has alkaline salts that help create alkaline media to neutralize acidic food from stomach.
-Enhance emulsification of fats into droplets
 - b) As the substance concentration decreases the rate of enzyme action decreases.
14. -Hydrogen ions, ATP molecules
-Oxygen gas
15. a) i) - Premolar tooth
ii) - Presence of two roots
- Presence of cusps on the crown.
- b) Has a blood vessel that provides nourishment to the tooth and remove waste products.
16. a) Vitamin D, Vitamin K
- b) - Transmission of nerve impulses.
- Ionic balance/osmotic balance
- Contraction of muscles.
17. a) In the stomach there is acid medium and ptyalin only acts at slightly alkaline medium.

- b) High temperatures above 40°C.
- c) -Villi
- Microvilli
18. a) Ingestion is the taking of food into the body.
- b) Digestion is the breakdown of large and insoluble molecules that can be absorbed.
- c) Absorption is the uptake of soluble food materials from lumen of digestive tract across the epithelial lining of the gut into blood stream.
- d) Assimilation is the utilization of absorbed food molecules by the body to provide energy or the materials necessary for growth, repair and reproduction.
- e) Egestion is the elimination of undigested waste food materials from the body.
19. a) They produce saliva. Saliva contains the enzyme salivary amylase (ptyalin) which begins the digestion of starch breaking it to maltose. It also lubricates food making it suitable for swallowing.
- b) It produces pancreatic juice. Contains NaHCO_3 which neutralizes the acid of chyme and creates a PH of 7-8 which is the Optimum PH for the action of pancreatic juice are;-
- Trypsin which digests protein to peptides.
 - Amylase which digests starch to maltose
 - Lipase which digests fats to fatty acids and glycerol

- c) It produces bile. Bile salts droplets a process called emulsification. This increases the surface area of the fat enhancing the action of pancreatic lipase.
20. i) It lubricates food
- ii) It prevents digestion of the gut wall by proteolytic enzymes
- iii) It makes food particles to adhere to one another during swallowing and during gestation.
21. Hydrochloric acid in the stomach denatures salivary amylase stopping its activity.
22. A sheep has the following herbivorous adaptations.
- It has a thick horny pad on the upper jaw over which vegetation is pressed by chisel-like incisors and canines on the lower jaw during feedings.
 - It has a diastema which provides space for tongue movements that separate grass which is being chewed by cheek teeth and grass that is newly gathered by front teeth.
 - Its premolars and molars have large top surface, which is worn out unevenly forming cusps which help in crushing and grinding of vegetation.
 - The joints of the jawbones are loose allowing up and down as well as sideways movement of the lower jaw, which aids in the grinding of vegetation.
 - Its rumen contains microorganisms that ferment cellulose releasing simple fatty acids that are absorbed by the animal.
23. i) Pepsin-digests proteins to peptides

- ii) Rennin-Coagulation of milk proteins to peptides
- iii) - Hcl-converts pepsinogen to pepsin
 - Kills bacteria in food
 - Provides an acidic pH (pH 1.5-2.5) which is the optimum pH for action of Pepsin
 - Unfolds proteins enabling pepsin to work on them.

24. This leads to lack of bile salts, which emulsify fats.

25.

	Nutrient	Food Source	Role in the body
a)	Vitamin A	Carrots, Liver, Egg yolk	Synthesis of rhodopsin (for proper function of retinal).
b)	Iron	Liver	Manufacture of hemoglobin
c)	Iodine	Iodized salt, sea food	Manufacture thyroxin
d)	Vitamin D	Fish, liver, plant oil, egg yolk	Aids assimilation of calcium phosphate for making teeth and bones.
e)	Protein	Meat, milk seed of legumes, fish	Making new cells/growth and repair of tissues.

FORM 2 WORK

CHAPTER 1

TRANSPORT IN PLANTS

1.
 - a) To investigate the effect of light on the rate of transpiration.
 - b) More water was lost in the light than in the dark. Rate of transpiration was greater in light than in the dark. This is because the stomata are fully open in light but less open or closed in the dark. In light, photosynthesis takes place hence no water used.
2. The leaves exposed a smaller surface area to the sun thus reducing transpiration.
Excessive water loss.
3.
 - Temperature- high temperature increase transportation. Low temperature lower transpiration.
 - Light intensity-more light increase transpiration, dim light lower transpiration.
 - Wind – strong wind increase transpiration, calm weather lower transpiration.
 - Humidity – High humidity lower transpiration, low humidity increase transpiration.
 - Atmospheric pressure- High atmospheric pressure increase transpiration.
 - Water availability-more water increase transpiration due to opening of stomata while little water lowers transpiration.
4.
 - a) A - Epidermis
B - Pith
 - b) C - Transport manufactured food/translocation

D - Produce new cells/divide giving new cells

E - Transport mineral salts and water.

c) -Xylem in centre/star shaped.

-Phloem in arm of xylem

-No pith in root

-Roots hairs present in root

5 a) K - Root hair

L - Xylem vessel

b) Water moves from the soil into the root hair by osmosis. Because concentration of cell sap is higher than water in the soil; the cell sap of the root hair is diluted thus making it less concentrated than neighbouring cells; therefore water moves into the neighbouring cell. It is then actively secreted into L.

c) Active transport/diffusion.

6.

- Lignified/thickened to prevent collapsing.
- Narrow to facilitate capillarity
- No cross wall for continuous flow of water.
- Side walls pitted to allow lateral movement of water and mineral salts.

7.

- Turgidity
- Presence of xylem vessels
- Presence of collenchyma

8.
 - a) R- sieve pore/plate
S-Cytoplasm strand
T- Companion cell
 - b) Translocation
 - c) Thickened, - Lignified
9.
 - a) Lignin,
 - b) Phloem
10. They are strengthened by lignin hence supporting the stem.
11.
 - Xylem - Transports water and mineral salts to photosynthesizing cells
 - Phloem - Transports manufactured foods from the leaves creating high concentration gradient.
 - Veins - Supports the leaf to be upright for maximum absorption of light for photosynthesis.
12.
 - a) Ovule
 - b) Ovary
13.
 - a) -Xylem vessels
-Sclerenchyma
 - b) -Turgidity of parenchyma cells
-Presence of collenchyma cells
14.
 - a) Dicot root
 - b)
 - i) Presence of root hairs
 - ii) Phloem between rays of xylem (star shaped xylem).

- c) J - Epidermis
 - K - Phloem
 - L - Xylem
 - d) Absorbs water and mineral salts from soil.
15. - Adhesion- force of attraction between unlike molecules
- Due to the force of adhesion water tends to stick to the walls of vessels containing it.
 - Cohesion- forces of attraction between like molecules
 - Cohesion between water molecules prevents the water column from breaking.
 - Root pressure- due to pressure generated by the root's endodermis
 - Capillary due to narrowness of xylem.
 - Transpiration pull- as water evaporates from the leaf's surface more is absorbed
 - After the water reaches the leaves cells, it passes the cells by osmosis from the xylem. Water vapour diffuses out through stomata.
16. - Absence of cuticle to allow diffusion of water.
- Thin walled to reduce distance of diffusion.
 - Elongated to increase surface area for absorption of water and mineral salts.
 - Presence of large vacuole to increase concentration gradient between cell sap and soil water.
- 17.
- a) Phloem tissues
 - b) K- Companion cell

c) Supply nutrients and energy to the sieve tubes.

18. a) Graph

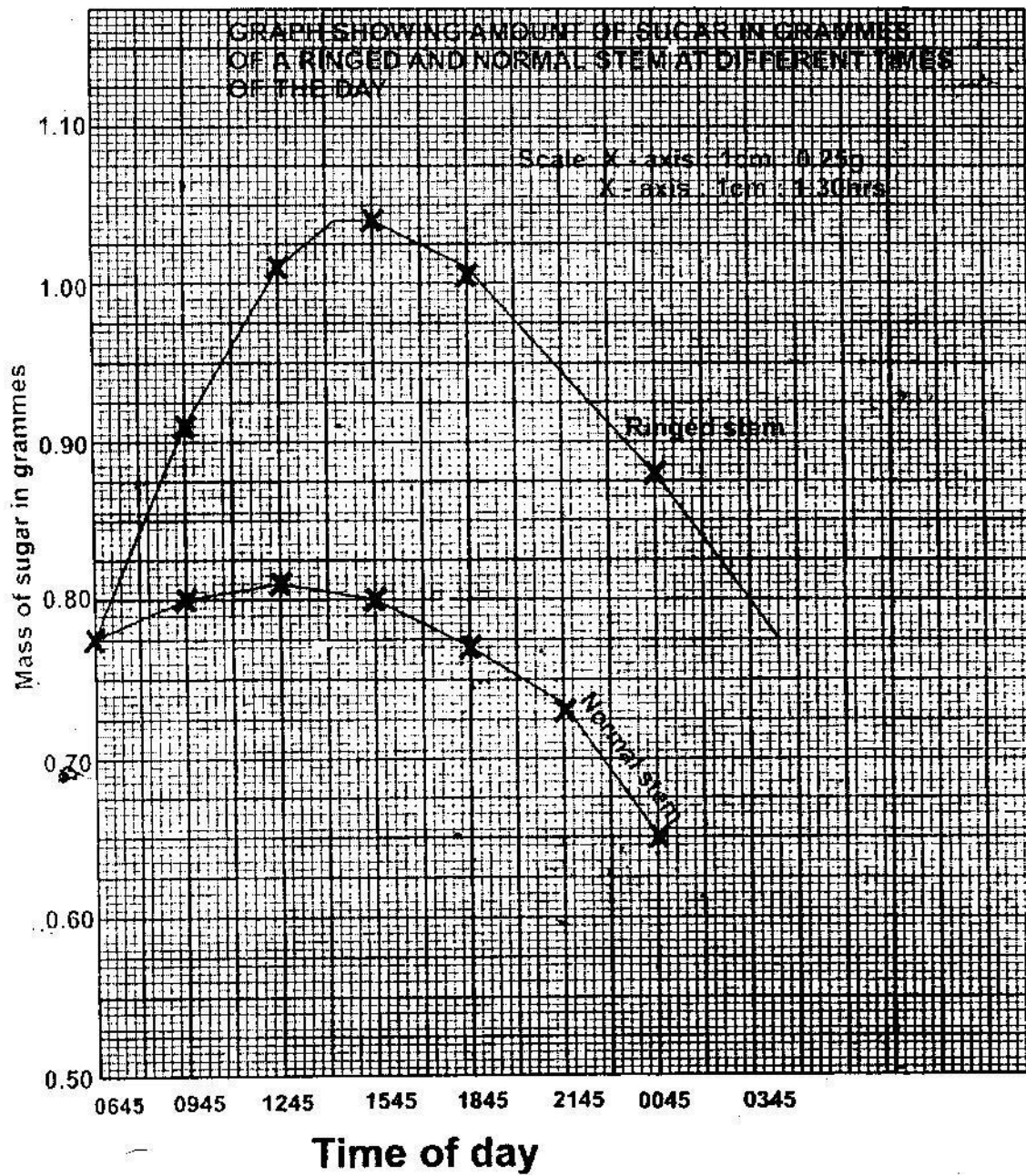

- b)
 - i) 15:45
 - ii) 12:45
 - c) 0.79 ± 0.02 grammes
 - d) The food that had been manufactured the previous day had been converted to soluble sugars and was being translocated to other parts of the plant.
 - e)
 - i) 06 45 hours and 15 45 hours.
 - There was low concentration of sugar early in the morning as there was little translocation.
 - As day progresses the light intensity increases and more food is manufactured thus more translocation increasing concentration of sugars.
 - ii) 15 45 and 00 45
 - The light intensity is decreasing reducing rate of photosynthesis. Less food is manufactured, hence less is translocated.
 - As it turns dark there is no photosynthesis reducing concentration of sugar translocated.
 - iii) Sieve plates
 - Cytoplasmic strands
 - f)
 - Amino acids
 - Soluble fats/lipids.
19. i) Reduce transpiration
- ii) Eliminate excretory wastes on the leaf
20. a) - Maintain transpiration stream

- Cool the plant
- Remove excess water
- Enhance absorption and distribution of water and mineral salts.

- b)
- Few and small leaves
 - Reduced leaf size
 - Sunken stomata
 - Thick cuticle.

CHAPTER 2

TRANSPORT IN ANIMALS

1. Carboxyhaemoglobin
2. Blood group **A** has antigens **A** on red blood cells and antibodies **b** in plasma.
Recipient's blood group **B** has **B** antigens and **a** antibodies. When blood group **A** from donor is transferred antigen **A** will react with antibody **a** in the recipient's blood. Clumping or agglutination of the red blood cells will take place: the clumped red blood cells block capillaries and this hinders the flow of blood and may result in death.
3. In a closed circulatory system, blood flow is confined to enclosed vessels while in open circulation blood is not confined to vessels but flows in cavities (sinuses) and is in direct contact with tissues.
4.
 - a)
 - i) Arthropoda
 - ii) Chordata
 - b) When blood is confined within vessels, it generates high pressure. This results in a faster rate of circulation, over long distances, ensuring efficient transportation of material e.g nutrient to all parts of the body, which renders the animals more active than those with open circulatory system.
5.
 - i) They contain haemoglobin, a molecule that readily combine with oxygen.
 - ii) They are biconcave discs without a nucleus, allowing more haemoglobin to be packed in cells so that each cell can carry more oxygen.
6.
 - a)
 - i) - Capillaries
 - ii) - They are thin-walled (one cell thick), thus allowing

diffusion of materials.

- b)
 - Have a small diameter to increase pressure thus allow materials to diffuse out.
 - They are intimately associated with tissues in order to allow exchange of materials
 - They are numerous- to provide a large surface area for exchange of materials.
 - c)
 - i) Pulmonary arterioles contain more carbon dioxide than pulmonary venules.
 - ii) Pulmonary arterioles contain less oxygen than pulmonary venules.
7. It does not dissociate easily hence leads to suffocation
8.
 - i) They contain haemoglobin, a molecule that readily combine with oxygen.
 - ii) They are biconcave discs without a nucleus, allowing more haemoglobin to be packed in cells so that each cell can carry more oxygen.
9.
 - i) Platelets (Thrombocytes)
 - ii) Calcium, Ca^{2+}
 - iii) Fibrin.
10.
 - a) Anemia/low blood volume/low haemoglobin leading to low oxygen, loss of nutrients and dehydration.
 - b) Blood clotting
 - c) Transfusion, taking fluids/eating iron in foodstuff/taking iron tablets.
11.
 - a)
 - Thrombosis
 - Arteriosclerosis

- Varicose veins
- b) - Regulate body temperature
- Regulate pH of fluids
- Regulate osmotic pressure
- 12. a) Presence of valves
- b) - Have biconcave shape to increase surface area for absorption of gases.
- Absence of nucleus and other organelles
- To increase packaging of haemoglobin.
- Presence of red pigment haemoglobin that has high affinity for oxygen.
- 13. - During birth
- Breast feeding
- 14. - Red blood cells have a biconcave shape, which increases the surface area for gaseous exchange. They have a thin plasma membrane, which allows rapid diffusion of gases. They contain haemoglobin, which readily combines with oxygen in areas of high oxygen tension (lungs) and releases it readily in areas of low oxygen tension (other body tissues). They have no organelles with whole internal space being filled with haemoglobin. They contain the enzyme carbonic anhydrase which help in the transport of carbon dioxide.
- Some white blood cells are phagocytic which enables them to engulf and destroy invading micro-organisms. They are also capable of amoeboid motion, which enables them to squeeze between cells of the capillary wall and into infected tissues where they proceed to engulf invading micro-

organisms other white blood cells called lymphocytes are able to recognize antigens of invading micro-organism and to form antibodies against them.

- Platelets are able to aggregate at the site of a damaged blood vessel forming a temporary platelet plug which stops blood loss. They also produce the substance called thromboplastin which initiates the blood clotting mechanism.
- Plasma is composed mainly of water which is a solvent for a large variety of substance. This enables it to act as a medium for transport of a large number of water soluble substances. It has a high heat capacity that enables it to transport heat from highly active tissues to the rest of the body.

15. Blood: Tissues which consist of a liquid part called plasma in which several types of cells are suspended.

Plasma: Liquid part of the blood

Serum: Plasma from which the blood clotting protein called fibrinogen has been removed. It does not clot.

Tissue fluid: Liquid part of blood without plasma proteins. It is derived from the blood by the process of ultra filtration.

Lymph: is a tissue fluid, which drains into lymphatic vessels instead of going back into the blood vessels.

16. a) The patient's red blood cells have antigen A on their membrane and his

plasma has anti-b antibodies .

The donor's red blood cells have antigen B on their membrane and his plasma has anti-a antibodies. After transfusion, the anti-b antibodies in the patient's plasma reacted with B antigens on the donor's red blood cell membrane. This led to clumping together of the donor red blood cells a process called haemagglutination. This may have caused blockage of capillaries in a vital organ like the heart or brain leading to death.

- b)
 - i) A,B,AB,O
 - ii) He is universal recipient. His plasma' lacks antibodies.
- 17. Active immunity-that is produced when an animal's body reacts to an antigen by producing antibodies.

Passive immunity- Immunity that is produced when antibodies are transferred from one individual to another.
- 18. Antibodies formed against common cold viruses remain in the body and provide immunity for only a few days. Therefore, once a person has recovered from cold, he/she is only protected for a few days. Those antibodies formed against measles virus remain in the body and provide immunity throughout the person's life.

Therefore, once a person has recovered from measles, he or she is protected for life.
- 19. PH of blood plasma is not altered homeostasis is maintained. Within the red blood cells, there is an enzyme (carbonic anhydrate) which help in fast loading/combinaton and offloading/dissociation of carbon dioxide.

20. Through tissues fluid, Oxygen and other food substance pass from the blood to the cells. Carbon dioxide waste substance passes from the cells to the blood through it.

CHAPTER 3

GASEOUS EXCHANGE

1. a)
 - Air enter into tracheal system through spiracles
 - It moves onto the tracheoles then moves on to the tips of tracheoles.
 - Air rich in oxygen dissolves in a fluid at the tip of the tracheoles. There is low concentration of oxygen in tissues as compared to the fluid.
 - Oxygen diffuses into the tissues due to concentration gradient. It is used in metabolic activities.
 - In tissues there is high carbon dioxide concentration than in the fluid in tracheoles.
 - Carbon dioxide diffuses from tissues into tracheole due to concentration gradient. It moves into trachea then out of the body through spiracles.
- b)
 - Water enters through the mouth when it opens its mouth. When it closes the floor is raised and water flows over the gills.
 - Oxygen diffuses into the gills blood capillaries while carbon dioxide diffuses from the blood capillaries along concentration gradient.
 - Flow of water and blood in gill filaments is by counter current flow.
2. a)
 - Large number of alveoli-increase surface area.

- Alveoli moist-dissolve diffusing gases.
 - This walls- allow quick diffusion of gases
 - Rich blood supply- transport oxygen and carbon dioxide.
- b) i) Carbon dioxide diffuses into the cells. It moves in the plasma or red blood cells.
- Carbonic acid in plasma or carbamino haemoglobin in red blood cells or hydrogen carbonate.
 - At the lungs hydrogen carbonate, carbonic acid and carbomino haemoglobin dissociates releasing cavity due to concentration gradient.
- ii) Due to metabolic activities carbon dioxide is released from mesophyll cell. It diffuses into the intercellular spaces.
- Due to concentration gradient the gas diffuses into the sub-stomatal air spaces.
 - When stomata open carbon dioxide is released into the atmosphere.
3. a) Carbon dioxide diffuses into the tracheoles then into the trachea and out into the atmosphere through spiracles.
- b) - Stomata.
- Lenticels
 - Cuticle
4. - To facilitate transportation of gases/exchange of gases i.e. oxygen and carbon dioxide.
- Create high concentration gradient.

- 5 a) - External intercostals muscle contract while internal intercostals muscles relax.
- Diaphragm contract flattening. Volume in thoracic cavity
- Air rushes into the lungs.
- b) Opening During the day photosynthesis takes place and sugar is formed in guard cells
- Osmotic pressure increases and water is drawn from neighbouring cells by Osmosis.
- The guard cells become turgid, bulge outward causing opening of stomata.
- Closing During the night there is no photosynthesis and sugar is converted to starch.
- Osmotic pressure decrease and water is lost to the neighbouring cell osmosis.
- Guard cells become flaccid, closing the stomata.
6. - Stomata
- Lenticels
- Cuticle
7. - High number of stomata on the upper surface of the leaf.
- Absence of cuticle to allow diffusion of carbon dioxide and oxygen.
8. a) - Pneumatophores
- Aerenchyma tissues
- Cuticle

- b) - The diaphragm flattens.
 - Volume in thoracic cavity increase.
 - Pressure decreases compared to atmospheric pressure. Air rushes into the lungs through the nostrils.
9. a) K- Pleural membranes
L - Alveolus
M- Intercostals muscles
- b) - Has c-shaped cartilage rings that support it, preventing it from collapsing and allow free flow of air.
 - Inner lining has mucus secreting cells that trap fine dust particles and micro-organisms.
 - Inner lining has hair like structures called cilia that enhance upward movement of the mucus to the larynx.
- c) Diffusion
- d) Mycobacterium tuberculosis
- 10 - Highly folded to increase surface area.
- High network of blood capillaries
 - Thin walled
 - Moist
11. The trachea are strengthened by rings of cartilage which prevent them from collapsing.
12. - The epidermis of the root hair cells do not have cuticle and gaseous exchange takes place.

- When soil is water logged oxygen cannot diffuse into the root tissues hence no respiration. Metabolic activities stop leading to death.
13. - Air is cleaned by the cilia in nostrils
 - Controlled amount of air is taken in through nose
 - Individual is able to detect the smell of air breathed in.
 14. - Spongy mesophyll cells are loosely packed allowing diffusion of gases.
 - Spongy mesophyll cells have a film of moisture on the surface to dissolve diffusing gases.
 - Large sub-stomatal air space in order to create high concentration gradient of diffusing gases.
 - Presence of stomata where gases enter or leave the leaf.
 15. - Carbon dioxide
 - Water vapour
 - Oxygen
 16. - Skin
 - Mouth
 17. - Mammals –alveoli
 - Fish – gill filaments
 - Leaves – spongy mesophyll cells
 - Amoeba – cells membrane
 18. Diffusion
 19. Support the trachea and prevent it from collapsing when there is reduced pressure.

CHAPTER 4.

RESPIRATION

1.
 - a) To derive off air or oxygen
 - b) To avoid killing yeast/Denaturing enzymes in yeast
 - c) To prevent air from getting into the yeast and glucose mixture.
 - d) Lime water turn to white precipitate
 - e) Use boiled yeast/glucose without yeast/yeast without glucose
2.
 - Lactic acid is toxic to tissues and must be removed from muscles to liver.
 - To increase supply of oxygen to tissues
3.
 - a) Anaerobic respiration
 - b) Brewing/Beer making
4.
 - Ethanol
 - Energy (ATP)
5.
 - Lactic acid
6.
 - a) Adenosine triphosphate (ATP)
 - b)
 - i) Beer brewing/wine making
 - ii) Baking using yeast.
7.
 - Have thin epithelium/wall to reduce distance of diffusion of the gases.
 - Moist to dissolve the diffusing gases
 - Highly folded to increase surface area for diffusion of gases.
 - Well supplied with blood or vascularized to help maintain high concentration gradient.
8.
 - a) A mouse has high surface area to volume ratio and tends to lose heat

faster. It required more energy to replace it.

A dog has low surface area to volume ratio and lose less heat. Less energy is required to replace it

- b) Lactic acid
9. a) i) Ethanol and carbon (IV) oxide.
ii) Lactic acid
- b) It is the state when human body undergoes anaerobic respiration producing lactic acid. Oxygen has to be taken into the body to break the lactic acid.
10. a) Ratio of carbon dioxide produce to oxygen used up during breakdown of a food substrate.
- b) $R.Q = \frac{CO_2 \text{ produced}}{O_2 \text{ used up}}$
 $R.Q = \frac{102}{145}$
 $R.Q = 0.7$
- c) Fat/ Lipid
- 11.

Aerobic respiration	Photosynthesis
<ul style="list-style-type: none"> - Take place in both plants and animals - Takes place in all body cells - Takes place during the day and night - Oxygen is taken up while carbon dioxide is removed. 	<ul style="list-style-type: none"> - Only takes place in plants. - Takes place in cells containing chloroplast - Takes place during the day only. Carbon dioxide used up while oxygen is given off.

12. a) Mitochondrion
- b) A - Outer membrane
B - Inner membrane
C - Matrix
D - Cristae
- c) Increase surface area over which respiration takes place:
- d) ATP

CHAPTER 5

EXCRETION AND HOMEOSTASIS

1. Pancreatic juice containing digestive enzyme is prevented from reaching food.
Insulin (and glucagons), which regulates sugar, is released directly into the blood stream.
2. a) Heat from the body metabolism is not lost to the surrounding through sweating because evaporation of sweat will be low; as air is already saturated with moisture.
b) Hypothalamus
3. a) Sweat produces does not evaporate due to high humidity and the body does not cool, hence more sweat produces leading to accumulation
b) Hypothalamus
4. - Elimination of uric acid requires less water than ammonia, hence (more) water is conserved.
- Uric acid is less toxic than ammonia hence safer to excrete where there is less water.
5. a) Regulation of blood sugar lowers blood sugar level/controls the conversion of blood sugar to glycogen/maintain correct blood sugar level (90-100mg/100cc of blood)
b) Controls the absorption of water in the kidney (tubules) nephron/regulation of water in the body/osmotic pressure in the blood.

6. More water will enter the amoeba (by osmosis) rate of water discharge by contractile vacuole will increase. Contractile vacuoles will be formed to discharge the excess water.
7.
 - i) Proteins/plasma; protein/fibrinogen; albumin, globulin, prothrombin.
 - ii) Blood cells, RBC/white blood cells/Platelets.
8.
 - Tests/React/Boil urine with Benedicts/Fehlings: positive results/Orange red precipitate is an indication of the disease diabetes mellitus.
 - Brick red instead of orange, use of Benedict's solution with boiling/heating.
9. After vigorous activity when blood glucose falls below normal.
10.
 - a) Diabetes insipidus
 - b) Anti-diuretic Hormone/ADH/ vasopressin
11. Maintenance of constant level of water, salts, osmotic pressure for optimum conditions for metabolism, suitable condition for cellular functions.
12. Converted into fats and stored as adipose tissue.
13.
 - a)
 - Most enzymes in the body function with a narrow range of temperature
 - High temperature denatures enzymes
 - Low temperature inactivates/inhibit enzymes
 - b) Sugar is a raw material for respiration therefore less sugar leads to low rate of respiration hence less energy available to the body/low rate of metabolism.
14.
 - a) Heat loss by conduction/convection from the blood vessels, the skin enters general circulation cooling the body.

- b) Vasoconstriction, thus less blood flowing to the skin surface thus reducing heat loss. Sweating ceases. Heat produced by shivering through metabolism is retained in the body.
15. a) Sebum
- b) - Cooling the body when water content evaporates.
- Excrete excess salts, lactic acid and urea.
16. - Regulates the blood sugar level in the body by converting glucose into glycogen.
17. - Adhesion- force of attraction between unlike molecules
- Due to the force of adhesion water tends to stick to the walls of vessels containing it
- Cohesion – forces of attraction between like molecules.
- Cohesion between water molecules prevents the water column from breaking.
- Root pressure-due to pressure generated by the root's endodermis.
- Capillary due to narrowness of xylem
- Transpiration pull-As water evaporates from the leaf's surface, more is absorbed.
- After the water reaches the leaves cells, it passes the cells by osmosis from the xylem.
- Water vapour diffuses out through stomata.
18. a) i) Maintenance of a constant internal environment of cells.
ii) Regulation of the concentration of water and salts in the body fluid.
- b) - Insulin - Glucagon
19. a) - The amino acids are broken into amino group (NH₂) and carboxyl group

(COOH). The amino group combines with hydrogen forming highly toxic ammonia. It immediately combines with carbon (IV) oxide forming urea that is less toxic.

- The carboxyl group are converted to carbohydrates and then oxidized or converted into neutral fats and deposited on parts of the human.
- b) - Bowman's capsule
- Proximal convoluted tubule
 - Distal convoluted tubule
- c) i) Less water reabsorbed in the blood stream and dilute urine is produced.
- ii) Diabetes insipidus
20. a) Excretion is the removal of metabolic waste products from the body of an organism.
- b) Secretion is the removal of a substance from a cell where it is formed and its transfer to another part of the body where it serves a useful function
- c) Egestion is the removal of undigested food material from the body of an organism.
21. Blood cells and plasma proteins
22. a) Ultra filtration
- b) Selective reabsorption
- c) Because the pores in the glomerular capillaries are too small for plasma protein to pass through.
- d) Blood cells

- e) Most of the water in the glomerular filtrate is reabsorbed by the urine is formed whereas very little urea is reabsorbed.
23. As moisture from the urine or saliva evaporates from the surface of the skin, it reabsorbs latent heat of vaporization from the body thus cooling it.
24. Being exothermic, fish do not spend any part of their food intake in the maintenance of body temperature. This is unlike the case with mammals which spend a significant part of their food on temperature maintenance. Therefore fish are able to spend more of their food intake on growth.
25. During hot dry weather, the humidity difference between the surface of the skin and atmospheric air is high. Under such conditions, sweat evaporates easily from the skin surface. This cools the body due to absorption of latent heat of vaporization. When the weather is hot and humid the humidity difference between the surface of the skin and atmospheric air is low. Evaporation of sweat takes place slowly with the result that sweat accumulates on the person's skin. Therefore the cooling effect of sweat on the body is greatly reduced.
26. Negative feedback refers to a regulatory mechanism whereby a deviation of the entity being regulated above or below the normal range triggers a sequence of event to bring it back to normal.
27. a) A - Hepatic artery
B - Hepatic portal vein
C - Hepatic vein
- b) i) B
ii) B

iii) C

iv) A

v) C

- c) During fasting there is no glucose from the alimentary canal making glucose concentration in vessel B low. Vessel C obtains glucose derived from the hydrolysis of glycogen in the liver.

FORM 3 WORK

CHAPTER 1 – CLASSIFICATION II

1. - Food spoilage
- Food poisoning
- Cause disease
2. a) A- Sorus
B- Rhizomes
b) Pteridophyta
3. Arthropoda
4. When they interbreed freely giving rise to a viable/fertile offspring.
5. Arachnida
- 6.

	Organism	Reason
Insecta	-Praying Mantis	- 3 body parts
	-Tsetse fly	- 3 pairs of legs
	-Centipede	-Many segments
	-Millipede	-Many legs
	-Tick	-2 body parts
	-Spider	-4 pairs of legs

7. - Presence of rhizoids
- Absence of vascular tissues
- Body parts not differentiated into roots, stem and leaves
8. - Brewing industry

- Baking of bread
 - Manufacture of medicine/antibiotics
 - Source of food
 - Manufacture of vitamin K and B12
9. Interbreed to produce fertile/viable offspring
 10. Cephalothorax; prosona.
 11. Chordata
 12. Class insecta
 13. Arachnida
 14. a) - Fungi
 - Saprophytic bacteria
 - b) - Refrigeration
 - Very low temperature inactivates the organism and metabolic activities are very low and they do not reproduce
 - Cooking –High temperatures kill the micro-organism and they cannot reproduce
 - Preservatives – create unsuitable acidic media in which micro-organisms cannot grow.
 - Salting – Create high osmotic pressure and micro-organisms become dehydrated.
 15. a) - They are closed circulatory system
 - They are homoeothermic
 - Both use lungs for gaseous exchange

- b) - They have mammary glands
 - Skin covered with fur or hair
 - They have diaphragm separating thoracic and abdominal cavities
16. - Have notochord in embryonic stage
- Have endoskeleton
17. a) A-Capsule B- Rhizoids
- b) Division Bryophyta
 - c) Gametophyte
 - d) - Vascular tissues absent
 - Body not differentiated into roots, leaves or stem.
 - Display alternation of generations.
18. - Number of body parts
- Number of appendages
 - Presence of wings
19. a) - Algae have chlorophyll but fungi do not have.
- Algae are single celled while fungi are multicellular.
- b) - Source of food for aquatic animals
- Manufacture of gels and paints
20. - Source of agar used in cultivating micro-organism
- Manufacture of gels and paints
 - Source of agar used in cultivating micro-organisms.
21. a) The spore producing structure (asexually) gives rise to the gamete producing structure (sexual) and they alternate.

- b) Division bryophyta
 - Division pteridophyta
22. a) - Segmented bodies
- Jointed appendages
 - Exoskeleton
 - Body divided into parts
- b) i) Second name should be in small letter. The names should be underlined.
- ii) Tuberrasum
- c) Division pteridophyta
23. Class diplopoda
24. - Number of body parts
- Number of legs
 - Number of wings
 - Number of antennae
25. Binary fission

CHAPTER 2

ECOLOGY

1. - May kill soil micro-organism that decompose humus to release mineral salts
- Soil structure interfered with encouraging soil erosion.
2. - Drought/food shortage /overgrazing
- Fire
- Emigration
3. a) The fish were caught, their age determined and the 2 year olds were retained and their length measured and recorded.
- This was done repeatedly until a large number were measure; calculation was done by dividing the total length of all fish by the total number of fish.
b) Lake A has hard water with more calcium while Lake D has soft water with no calcium. Calcium is necessary for bone formation. Fish in Lake A grow faster and greater bone length than fish in Lake D. Lake C has more food which fish eat than Lake D.
c) Lakes C and D have little or no calcium which is necessary for the formation of the shell in snails.
d) i) Light temperature, carbon dioxide concentration, oxygen concentration, PH and salinity.
ii) Light-Affects the rate of photosynthesis.
Temperature- Affects enzyme activities hence photosynthesis.
CO₂ concentration – Determines rate of photosynthesis.

O₂ Concentration- affects rate of respiration.

Salinity – Osmoregulation in plants and animals.

PH – Affect enzyme activities.

4. a)

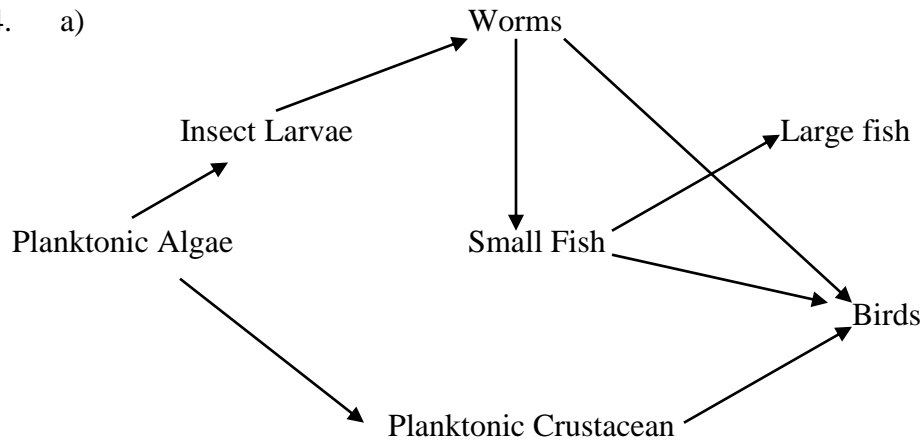

b) i) Planktonic algae → Planktonic crustacean → Birds

ii) Planktonic algae → Planktonic crustacean → Small fish → Large fish

c) Producers must always have a higher biomass than consumers because they support the consumers which are at higher trophic levels

d) i) Pollution – herbicides and pesticides, over fishing, bird hunting

ii) Herbicides and pesticides – kill insect and planktonic algae reducing their number.

- Fishing increases planktonic crustaceans and insect larvae leading to over consumption of algae depleting them.

- Decrease in number of insect larva.

5. i) A- Desert, arid and semi-arid

B- Aquatic, marshy land

6. a) i) 1968

- ii) Hot water, sewage and industrial waste.
- iii) High temperature reduces dissolved oxygen causing suffocation of fish.
 - Sewage leads to eutrophication reducing oxygen concentration and reduces penetration of light.
 - Industrial waste- toxic substance kills the organism.

b) i) A = $7512 - 20 = \frac{7492}{5}$
 = 1498.4 fish per year

 B = $617 - 23 = \frac{594}{5}$
 = 118.8 fish per year

 Difference = 1379.6 fish per year

- ii) - Reproductive rate
 - Competition
 - Predation
 - Sex ratio

- c) i) Capture/recapture method
- ii) Marks may disappear
 - During marking fish may be killed
 - Predation/death may interfere.

- 7. The pollutants may be absorbed by aquatic plants which in turn may be eaten by fishes. The pollutants therefore get into man through the food chain.
- 8. - Improving sanitation to prevent infection by parasite.
 - Insecticide to kill vector like mosquitoes or tsetse fly.

- Avoid indiscriminate sexual intercourse to prevent spread of parasites.

9. a) Green plants → Grasshoppers → Lizards → Snakes
Green plants → Grasshoppers → Lizards → Cats
Green plants → Mice → Snakes → Hawk
Green plants → Mice → Snakes → Cats
- b) Mice
- c) Lizard, cats, hawk, snakes.
- d) Most plants will die
Some organisms will starve and die
Some organisms may migrate.
10. a) Population size
$$N = \frac{374 \times 400}{80} = 1870$$
- b) There was even distribution of crabs; No movement in and out of lagoon/on migration. There was random distribution of crabs after first capture
- c) Capture, mark, release then recapture/capture/recapture method.
- .
11. a) Grass → Grasshopper → Guinea fowls
Grass → Termite → Guinea fowls
- b) Lions would compete with leopards
Gazelle number would reduce
Grass would be increased

- c) Grass
- 12. a) E -Denitrifying bacteria
J - Nitrifying bacteria
- b) F- Nitrogen fixation
H-Decomposition
- c) G-Plants
- 13. a) Community – it is the total number of plants and animals living together in an area.
 - Population- total number of organisms of a given species occupying an area at a certain trophic level
 - b) - Use of net to capture the grasshopper
 - Which are then counted and marked. They are then released.
 - Total number of grasshoppers is determined by multiplying the grasshoppers captured second time by those captured and marked first time.
 - The sum is divided by number of grasshoppers marked in second capture.
- 14 - During manufacture of sulphuric acid and nitric acids oxide of sulphur and nitrogen are released into air causing acid rain.
 - Motor vehicle exhaust fumes release carbon monoxide a respiratory poison.
 - Combustion of fuels and coal increase concentration of carbon dioxide creating greenhouse effect.

- Aerosols containing CFC in herbicides and perfumes deplete the ozone layer.
- Smoke from factories mix with fog forming smog which reduces visibility.
- Exhaust fumes from vehicles contains lead from leaded petrol that poisons the body.
- Deforestation exposes top soil to air currents encouraging sheet erosion
- Leaded petrol that poisons the body.
- Loud noise from factories, aeroplanes and Jua Kali workshops can lead to poor hearing ability.
- Radio active emissions can lead to mutations.

15. Curved sharp hooked strong beaks for killing or tearing flesh from bones.

Curved strong sharp claws for holding prey.

16. a) Crop- potato/tomato
- b) Disease- potato blight/tomatoes rot
- c) - Use of fungicides
- Uprooting and burning infected plants
 - Crop rotation
 - Use biological control
 - Use disease resistant varieties

17. Cattle are mainly grazers while most wild animals are browsers.

18. a) i) Study of a single species within a community or ecosystem.

- ii) Study of different species of organisms in a natural community in an ecosystem.
 - b) A-Aquatic/Fresh water
B- Forest
C- Arid- Semi Arid
 - c) - Sunken stomata,
- Reversed rhythm
- Small stomatal pores
19. Entamoeba historical
- 20.
- a) Photosynthesis
 - b) Heterotrophic
 - c) Aquatic (pond) and terrestrial (forest)
 - d) Algae → Zooplankton → Small fish → Bird J → Large bird
 - e) - Number of snails would increase
- Green plants would decrease.
- Bird M would increase
 - f) In a lower trophic level energy is lost through respiration, excretion and death of some organisms.
 - g) i) - Vultures
- Decomposers
ii) Vultures- control population of the large birds.
Decomposers- cause decay of dead organisms recycling the nutrients.

- h)
 - i)
 - Deforestation
 - Bird hunting
 - Over fishing
 - ii)
 - Removal of the trees destroys the habitat for birds, they therefore migrate.
 - Bird hunting kills the birds reducing their number and increasing small fish, mussels and snails.
 - Over fishing reduces the number of small fish increasing zooplankton and reducing the algae
21. - Cells have large air spaces between them to enhance buoyancy.
- Cells are air filled reducing their density.
22. **Light**- high light intensity increase the rate of photosynthesis
- Temperature**- low temperatures lower metabolic activities while moderate temperature increase metabolic activities. High temperature increases transpiration.
- Wind**- Strong air current increase rate of transpiration and deforms the plants according to direction of the wind.
- Atmosphere pressure**-High pressures decrease the rate of transpiration and also reduces rate of photosynthesis.
- Ph value**-some plants thrive well in acid soils while others thrive better in alkaline soils.
- Radioactive radiations**- Cause mutations of the offspring
- Oxides of sulphur and nitrogen**-cause acid rain that corrodes plant leaves.

23. In different continents, regions with similar climatic conditions and lie in the same latitudes have plants and animals not identical.
24. a) Decomposers – Cause breakdown of organic matter enhancing recycling of nutrients
- b) Predation - The organism feeds on whole or part of another organism and therefore control their population.
25. X- Denitrification
- Y- Animals
- Z- Nitrification
26. Offspring (brown fur) = $\frac{2}{4} \times 100 = 50\%$
- a) Pyramid of number Way numbers of individuals occurring at each trophic levels of a food chain may be diagrammatically represented.
- Pyramid of biomass The way the total amount of living matter occurring at each trophic level of food chain may be diagrammatically represented.
- b) Loss through excretion e.g. egestion
- Heat
 - Respiration
- c) Two parallel strings are laid down over a determined length and width within study area.
- No. of organisms in belt transect are counted.
 - Area transect is worked out.

- Number of organisms per unit area is worked out.
27. a) Population – It is all members of a given species in a particular habitat at a particular time.
- Community – All organisms belonging to different species that interact in the same habitat.
- b) i) Capture and recapture method.
- ii) Line transect
28. - Produce large number of eggs for increased survival.
- Produce enzymes to digest human skin when penetrating.
 - Can withstand low oxygen concentration.
 - Have hook-like structures to attach to the intestinal walls.
29. - It is addition of substances into water that may cause harm to organisms and are destructive to the ecosystem.

The causes of water pollution include;

- Industrial effluents that may be toxic chemicals which may kill the aquatic organisms. It can be controlled by treating the affluent before discharging them.
- Hot water that reduces concentration of oxygen, killing the animals. It is controlled by placing high penalties on factories discharging hot water.
- Oil spillage from oil tankers that reduces oxygen in water, penetration of light intensity and clog feathers of marine birds. It can be controlled by regular servicing of oil tankers.
- Domestic effluents that include;

- Untreated sewage that causes water borne diseases. It can be controlled by treating sewage before being discharged.
 - Detergents that cause eutrophication causing reduced oxygen concentration. It is controlled by banning phosphate based detergents.
 - Agricultural effluents that include;
 - Pesticides and herbicides that have heavy metals that they may accumulate along the food chain killing the higher animals. It is controlled by banning phosphate based detergents.
 - Inorganic fertilizers that have nitrates and sulphates that cause eutrophication. It is controlled by use of organic fertilizers.
 - Silting due to soil erosion that reduces penetration of light to the plants and clog respiratory surfaces of animals. It is controlled by proper methods of soil erosion control and proper farming methods.
30. a) It is use of natural predator to kill a prey e.g pest instead of use of pesticide.
- b) The aphids are pest found in plants. The ladybirds can be used to control the aphids as they feed on them but not destroy the plants
- c) Prey is the source of food for predators. If the number of prey is smaller than the predators they would be depleted.
31. a) Antelopes are grazers while giraffes are browsers.
- Antelopes have brown fur being camouflaged by the colour of grass while giraffes are camouflaged by the trees.

- b) Trees are camouflage against the herbivores preventing them from being spotted by predators. In open grassland herbivores are easily spotted.
 - c) The population will first increase leading to competition of resource e.g. food or mates. This causes death of the weak herbivores or migrations to new habitats.
32. - As it gets deeper light penetration decreases reducing rate of photosynthesis hence less productivity.
- As it gets deeper carbon dioxide concentration decrease hence reducing rate of photosynthesis hence less productivity
33. a) Plant protein
- b) X-Nitrification
Y-Nitrogen fixation
Z- Dentrification
- c) Proteins
34. a) i) $25-10 = 15$ birds
ii) $20-5 = 15$ birds
- b) i) The number of species in forest are more than in the number in the savannah hence higher change.
Fruits more abundant in forest than in savannah
Selectively reduces with forest birds because they are many and competition is stiffer than savannah
- ii) Seeds more abundant in savannah than in forest-they they are more exposed but seeds in forest plants are inside the fruit.

Birds in savannah are less selective than forest birds.

c) i) B

ii) - Emigration in big numbers

- High death rate during unsuitable condition and disease.
- Predation increase due to attraction of predator due to their high number.

d) - Bush fire –avoid lighting fires

- Eliminating all predators of one herbivore
- Limited predator to maintain high biological control.
- Felling trees- replanting trees
- Having high concentration of industries that provides that cause acid rain.
Use of fuels that do not produce the oxides.

CHAPTER 3

REPRODUCTION IN PLANTS AND ANIMALS

1. Prophase
2. Integuments, triploid nucleus
3.
 - Blood entering placenta has more oxygen, more food substances, less nitrogenous wastes and less carbon dioxide.
 - Blood leaving placenta has less oxygen, less food substance, more carbon dioxide and nitrogenous wastes.
4. Corpus luteum in the ovary secretes progesterone, which maintains pregnancy/development of uterus after four months pregnancy is maintained by progesterone from placenta.
5.
 - Protandry / protogyny / male and female parts mature at different times
 - Stigma positioned higher than stamen
 - Incompatibility /sterility.
6.
 - Presence of special structures that attract agents of pollination.
 - Protandry /protogyny
7.
 - To increase the chances of fertilization and survival of species.
8.
 - a) Wind
 - b) To enable it trap pollen grains in the air.
9.
 - Blood transfusion
 - Use of unsterilized instruments / sharing (contaminated) instruments.
 - Infected mother to foetus; infected mother to newborn.

10. Bring about change or genetic material, which leads to variation that enables organisms to exploit new environment resistance to disease.
11. - Lack of variations
- Lack of hybrid vigour
 - Disadvantageous traits are retained within species.
12. a) Meiosis
- b) Ovary
 - c) n- gametes
 - 2n- parents
13. a) i) Conditions where other floral parts arise / positioned above the ovary / inferior ovary.
- ii) Male flower
- b) -Large anthers loosely attached to the filament to be easily shaken in the wind.
- Small / smooth / light pollen grains – easily carried by wind.
14. a) Ovule
- b) Ovary
15. a) - Sister Chromatids separates.
- Chromatids start moving to opposite poles with centromere first.
- b) - Ensure that gametes formed have half the number of chromosomes found in original cell.
- Formation of sex cells.
 - Leads to variation of genetic material during crossover.
16. a) i) Protoandry Stamens with pollen grains matures before carpel (stigma)

of the same flower.

- ii) Self-sterility Pollen grain of anthers cannot grow into pollen tube on the stigma of the same flower.

- b) - Mixing of genetic composition of different plants.
 - Offspring produced has high yield.
 - Offspring is more resistant to disease and adverse conditions.

17. a) Amnion

b) i) – Umbilical vein

- Umbilical artery

ii) – Umbilical vein – rich in nutrients and oxygen.

- Umbilical artery – rich in CO₂ and waste like urea.

- c) - Has thin membrane to reduce diffusion distance.
 - Has villi which increase surface area for exchange.
 - Highly vascularized.

- d) - Cushions foetus against shock
 - Supports the foetus
 - Keeps foetus moist (prevent dehydration)

18 a) i) Anaphase I

- ii) - Homologous chromosomes separate at the equator.
 - Chromosomes start migrating to opposite poles
 - Sister chromatids attached at the centromere.

b) Spindle fibers.

19. - Harmful characteristics from the parents may be passed on to the off springs.

- Takes a longer time
- Few offsprings are produced at a time.

20. a) i) Protandry Stamens mature and pollen grains are shed off before the stigma matures.
- ii) Self sterility Pollen grains from the anthers cannot grow on the stigma of the same flower or plant.

- b) i) Q- Antipodal cells
 R- Polar body / polar nucleus
 S- Egg cell

- ii) Path through which the male gametes reach the embryo sac to enhance fertilization.

- iii) Prevent other pollen grains from developing into pollen tubes hence no multiple fertilization of embryo sac.

c)

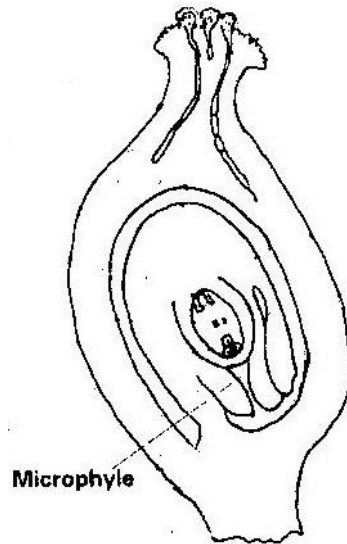

21. a) i) Large brightly coloured corolla / inflorescence / forests / tracts to attract insects.
- ii) Scented to attract insects
- iii) Have secreted nectar to attract that direct flowers secrete nectar to attract insects.
- iv) Pollen grains rough/spiky sticky surface to stick on insect's body.
- v) Special shaped corolla tube to enable the insect land.
- b) i) Repair / heal endometrium / wall of uterus, which is destroyed in menstruation. Stimulates pituitary gland to produce the luteinising hormone
- ii) Stimulates the thickening of the uterus, increases the blood supply to the endometrium. Inhibits the production of follicle stimulating hormone
- iii) Responsible for maturation of the graafian follicle / causes ovulation. Stimulates corpus luteum to secrete progesterone.
22. - Interior lobe of pituitary glands secretes follicle stimulating hormones (FSH). FSH causes Graafian follicle to develop in the ovary. It also stimulates tissues of ovary / all of graafian follicle to secrete oestrogen.
- Oestrogen causes repair /healing of uterine wall; oestrogen stimulates interior lobe of pituitary to produce Luteinsing Hormone which causes ovulation. It also causes graafian follicle to change into corpus luteum and stimulates corpus luteum to secrete progesterone.

- Progesterone causes proliferation of uterine wall in preparation for implementation.
 - Oestrogen/progesterone inhibits the production of FSH by anterior lobe of pituitary thus no more follicles develop and production reduces.
 - In the next two weeks, progesterone level lowers and inhibits production of LH from anterior lobe of pituitary.
 - The corpus luteum stops secreting progesterone and menstruation occurs when the level of progesterone drops. Anterior lobe of pituitary starts secreting FSH again.
23. i) It forms a large surface area for the diffusion of nutrient from the maternal blood to the foetal blood. Glucose, amino acids and salts are transferred.
- ii) The placenta isolates the foetus from the higher blood pressure of the mother and from direct connection of the two blood systems. Excretion materials can easily pass from foetus to mother.

CHAPTER 4

GROWTH AND DEVELOPMENT

1. IAA /auxins produced by terminal bud; inhibits growth of lateral buds, when cut the suppression cease thus auxiliary buds sprouts.
2. Food stored is used in (mobilized) up for respiration and growth.
3. - They promote cell division
- Promote fruit formation without fertilization/ parthenocarpy.
4. a) Oxygen is necessary for germination
b) Germination in B, no germination in A.
5. The adult and larvae exploit different food riches; do not compete for food.
6. Endosperm material was converted into new cytoplasm/ the stored food endosperm is used up to the germination seed while the embryo is growing and adding on more protoplasm.
7. a) Condition necessary for the germination of seed /to show that water, oxygen and warmth are needed for germination.
b) To absorb all oxygen from the jar
c) C- to show water is needed for germination of seeds.
d) Jar A – seeds would not germinate
Jar B – seeds would has germinated
e) i) Scarification i.e. scratching to make impermeable seed coat permeable
ii) Vernalisation – Cold treatment e.g. species of wheat.
8. a) Apical bud produce auxins which inhibits the development of lateral buds.

Removal of terminal buds cause the growth and development and sprouting of lateral buds.

- b) The pruning of coffee/tea.
 - c) More yield /production
9. a) Low oxygen and increase in CO₂
- b) Germinating seeds respire using O₂ and release CO₂ only.
 - c) Absence of light, impermeability of seed coat to water, immature embryo, lack of growth hormones presence of inhibitors.

10.

- Epigeal germination – Epicotyle grows very fast pushing out of soil surface with the cotyleons.

Hypogeal germination – Epicotyle grows very fast and plumule grows out forming first foliage leaves cotyledons remain underground.

11. a) Graph

b) i) 68 ± 1

ii) 130mm

c) Shoot A- Removal of apical bud promotes growth of lateral buds, due to removal of auxins hormones which inhibit lateral bud development.

Shoot B- Gibberellic acid promotes growth of lateral branches

Shoot C- Presence of apical bud inhibit lateral bud development due to reserve of auxins. This is called apical dominance.

- d) As a control experiment to show the effect of hormones (auxins) on lateral bud development.
 - e) - Promotes flowering.
 - Promote lateral bud development hence increase yields.
 - Break seed dormancy (promote germination)
 - f) - Germination
 - Flowering
 - Activate hydrolytic enzymes
12. a) - Absence of water (moisture)
- Unsuitable temperature.
 - Lack of oxygen
 - Lack of light
- b) Hypocotyls
13. a) - Increase in dry mass
- Increase in cell number
 - Irreversible increase in volume of cytoplasm
 - Increase in differentiation.
- b) i) Light intensity influence rate of photosynthesis.
- ii) Temperature – influence metabolic rate via enzyme action.
- c)

Name of hormone	Site of hormone production	Effect
Thyroxin	Thyroid gland	Control basal metabolic rate
Follicle stimulating hormone	Anterior pituitary gland	Maturation of Graafin follicle
Auxins	Stem of apex Root apex	Cell elongation
Gibberellins	All young plant tissues	Stimulates cell growth

14. a) It indicated the amount of organic material present which is a measure of change in mass cytoplasm.
- b) Weigh, reheat at 110⁰C for several hours, and cool constant Mass.
- c) Most of mass is starch which is converted to sugars and used up in respiration and other metabolic activities.
- d) Cellulose is synthesized during growth of new cell walls.
- e) Starch → Glucose → Cellulose

FORM 4 WORK

CHAPTER 1 –

GENETICS

1. a) - Ribonucleic acid
 - Has the base 'U' uracil
- b) -G- C –A – G
2. RNA DNA
 - a) Has ribose sugar Deoxyribose sugar
 - b) Has uracil as one Has thymine of its bases
 - c) Single strand Double strand
3. Haemophilia (sickle cell anaemia)
4. Controls / regulates enzyme / synthesis for the material for inheritance.
5. Gametes form new offspring
6. Co-dominance / incomplete dominance
7. - High yielding Hybrid vigour
 - Resistance to disease, early maturity.
 - Resistance to drought early maturity.
8. Y Chromosome – Hairy pinna, tuft and hair sprouting from the pinna, baldness.
X Chromosome – Colour blindness; Haemophilia
9. a) Smooth seed coat is dominant to wrinkled seed coat. Let R represent gene for smooth and parental genotype RR x rr

R R r r

	R	R
R	Rr	Rr
R	Rr	Rr

All F1 areRr

Parental genotypes Rr X Rr

Gamete

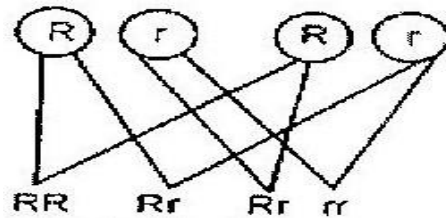

F2 genotypes

- i) Genotypic ratio 1RR : 2Rr: 1rr
- ii) Phenotype ratio 3 smooth: 1 wrinkled
- iii) Wrinkled number $\frac{1}{4} \times 7324 = 1831$

10. a)

Parental genotypes RR x WW

Gametes

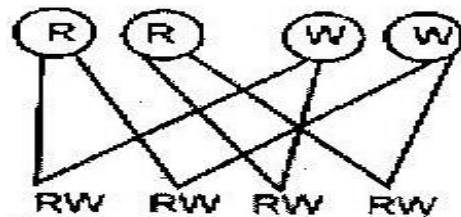

F1 genotypes

- b) 1:2:1 for ratio, 1 white: 2 pink: 1 red
- c) Co-dominance / incomplete dominance / partial dominance / equal dominance.

11. a) White

- Fewer number / lower rates / absence of white in parent and its presence in offspring.

b) Heterozygous/ Rr

c) Homozygous / rr / double recessive.

12 a) i) Haemophilia

ii) Sickle cell anaemia

iii) Colour blindness

iv) Leukemia

v) Albinism

b) i) Inversion- A result of a chromosomal break up and rejoining with the middle piece turned by 180°

ii) Translocation- A section of chromosome breaking and joining a homologous chromosome.

c) Phenotype: Black mice x Brown mice

Genotype Bb x bb

Gametes B b b b

F1 genotype Bb Bb bb bb

Phenotype 2 black : 2 brown

13. a) It is alternative form of a chromosome been similar in structure but may have different composition.
- b) i) Occurs when the nucleotides of a gene break off and disappear
 ii) Occurs when the nucleotides of a part of a gene become inverted by taking a 180° turn.
- c) Testing the genotype of an individual by crossing with the recessive trait.
14. a) i) Parents Homozygous x Heterozygous phenotype purple grains purple grains

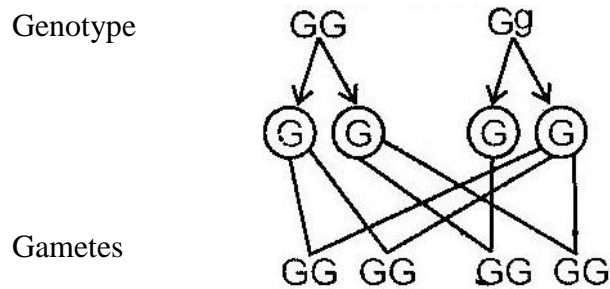

1st filial generation

(Off springs)

- The genotype ratio:
 - 2 homozygous purple coloured grains
 - 2 heterozygous purple coloured grains
- ii) All purple coloured grained maize plants maize plants.
- b) Deliberate modification of a characteristics are of an organism by manipulates genes and DNA by transferring genes from one organism to another.

c) It is when best characteristics are developed from both parents and offspring better than either parent.

15. i) Alleles are alternative forms of the same gene which control the inheritance of contrasting features of the same position in homologous chromosomes.

ii) Genotype is the genetic makeup or composition of an organism.

iii) Phenotype is the outward appearance of an organism with reference to a particular trait.

16. a) The genes for dark red colour and white colour are co-dominant. Since the calf is heterozygous it gets a coat colour that is intermediate between dark red and white

b) Let R represent the gene for dark red coat colour and W the gene for white coat colour. The light red bull must be heterozygous (RW) and the dark red cow must be homozygous (RR)

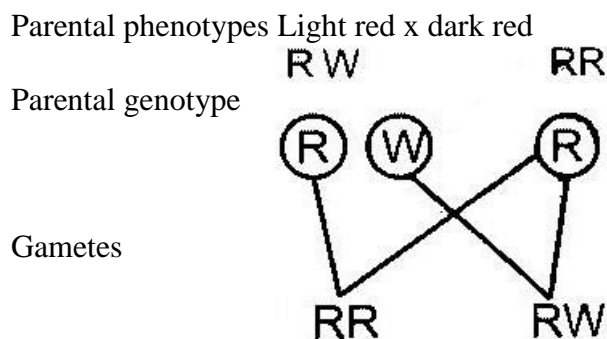

Offspring genotypes

Offspring phenotypes Dark Red Light red

17. a) Linked genes are those genes that are found in the same chromosomes. They are usually inherited together.
- b) These observation show that eye colour in fruit flies is a sex-linked trait. Since it is well known that the Y chromosomes carries very few genes, we can assume that eye colour in fruit flies is an x-linked trait.
- When a true-breeding, red-eyed female is mated with a white-eyed male, all the offspring received an X-chromosome carrying the dominant gene from the mother. Because of this, they all develop red eyed. This is illustrated below.

Parental phenotypes Red eyed female x white eyed m

Parental genotype

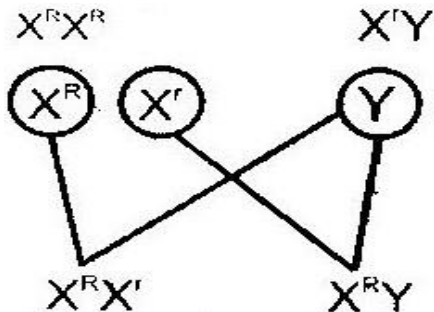

Gametes

Offspring genotypes

Offspring phenotypes	Red eyed	Red eyed
	females	males

When a true breeding white eyed female is mated with a red-eyed male, the female offspring receive an X-chromosome carrying the dominant gene from the father and develop red eyed. The male offspring received an X-chromosome carrying the recessive gene from the mother. They also receive a Y chromosome contains no genes for eye colour the male offspring develop white eyes.

i) Parental phenotypes White eyed female x Red eyed male

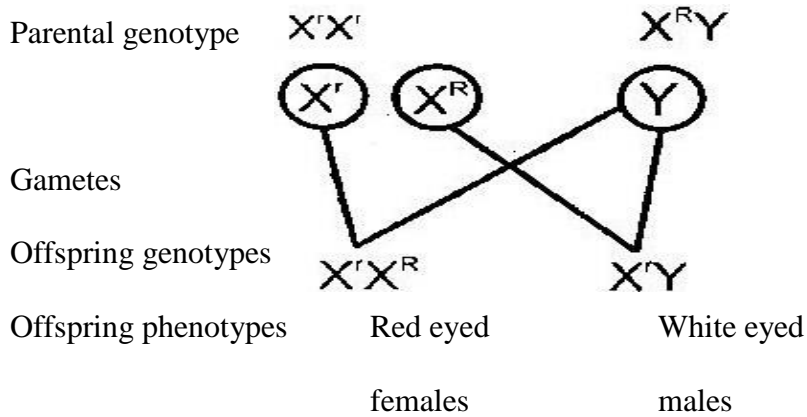

ii) Parental phenotypes red eyed female x white eyed male

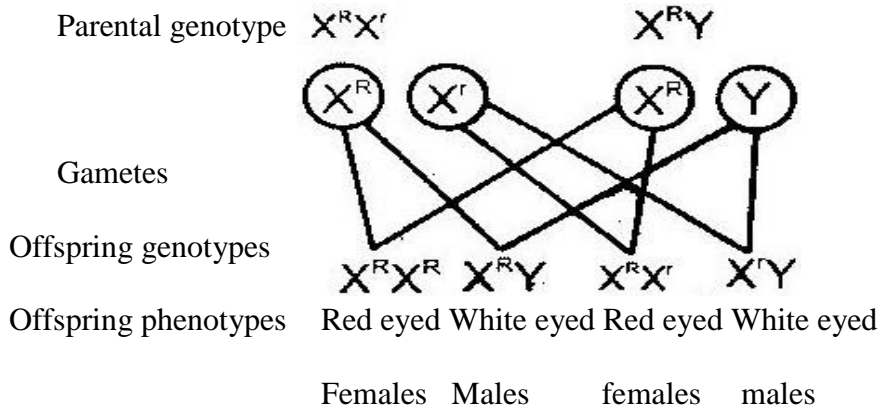

18. a) Variation refers to the difference in specific characteristics that exist between members of a species e.g. in humans, characteristics that exist between members of a species e.g. in human, characteristics such as height, blood group.

- b) Discontinuous variation refers to the existence of two or more distinct forms between them e.g. pink or white flowers in pea plants
- Continuous variation refers to the existence of a characteristic in a continuous gradation between two extremes e.g. height, weight and fruit size in trees.
- c) Genetic variation provides the raw materials for evolution by natural selection. It increases the chances of survival in an ever-changing environment. If a particular species is highly adapted to a specific habitat, it might find it difficult to survive in case there is a sudden change in the environmental conditions. In absence of variation, such a change may lead to death of all members have a variation that adapts them to the new conditions they will survive. They will reproduce and multiply rapidly in the absence of competition from other forms. Since the variation is genetic, the adaptation is passed on to subsequent generations.
- d) When DDT was first used in the 1950's it was very effective in killing mosquitoes. In areas where mosquito populations were previously large, their numbers were greatly reduced. However, in the 1960's the number of mosquitoes in these areas began to rise again despite the continued application of DDT.
- It then became evident that a few mutant forms had a variation that made them resistant to DDT. In the absence of competition from other forms, the resistant forms reproduced and multiplied very fast. The result was that the number of mosquitoes started to arise again despite the continued application of DDT.

Thus the presence of a variation in the few mutant forms saved mosquitoes from extinction.

19. a) They represent the bases guanine, thymine, cytosine, adenine
- b) It is a DNA strand because it contains the base thymine which is absent in RNA.
- c) C A A T C G A C T
- d) C A A T C G A C U

20. Human females produce one type of egg containing an X chromosome. Males produce two types of sperms; half contains a X-chromosome and the other half contains a Y chromosome.

Fertilization of the egg by a sperm carrying an X chromosome gives rise to a baby girl.

Fertilization of the egg by a sperm carrying a Y-chromosome gives rise to a baby boy.

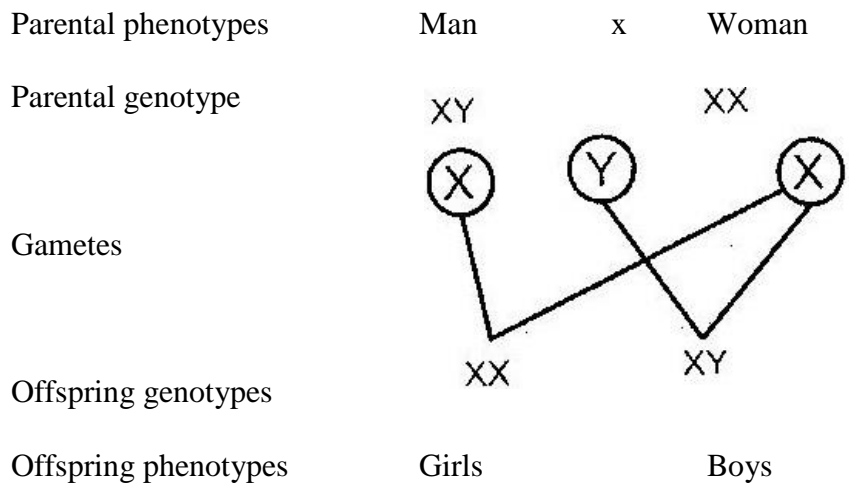

CHAPTER 2

EVOLUTION

1.
 - Lamarckism- a character acquired in the life of an organism which is favourable in its adaptation to the environment is inherited.
 - Darwinian Theory – As a result of variations, some organisms become better adapted to the environment. They therefore survive better and mature giving rise to more adapted offspring.
 - The less adapted organisms die before maturity hence are eliminated from the environment.
 - The less adapted organisms die before maturity hence are eliminated from the environment.
2. Adaptive radiation / divergent evolution 1995
3.
 - Evidence does not support Lamarck's theory.
 - Acquired characteristics are not inherited/inherited characteristics are found in reproductive cells only.
4. Fossils/ (records), palaeontology, Geographical distribution, comparative anatomy/taxonomy; cell biology; comparative serology; comparative embryology; comparative immunology.
5. Assists to eliminate disadvantageous characteristics / perpetuate advantageous characteristics.
 - Allow better-adapted organisms to survive (adverse changes) in environment/less adapted organisms are eliminated by adverse changes in the environment.
6. a) Gives evidence of types of plants, animals, organisms that existed at certain

geological age/ long ago.

b) Gives evidence of relationship among organism / common ancestry of a group of organisms.

7. Nature selects those individuals who are sufficiently well adapted; rejects those that are poorly adapted

8. - For a new species to be formed, a population of organisms must become completely isolated or separated from the others; Over long period of time so that any new variation that rise will not therefore flow to other population.

- Geographical isolation – this is due to physical barriers e.g. oceans / seas / deserts

- Ecological Isolation- a barrier resulting form the occupation of different types of habitats from the original type.

- For reasons of feeding/ predation / breeding as well as environmental changes (e.g. climate and vegetation which may result in population living in different habitats so becoming, ecologically separated from one another)

- Behavioural isolation alteration in behaviour proceeding mating which include courtship behaviour / lack of attraction between males and females in different chemicals / pheromoes / coloration /songs e.t.c

Reproduction isolation: a barrier to successful mating between individuals of population; due to structural differences in reproductive organs as well as failure in fertilization/ incompatibility.

Genetic isolation – Even if fertilization takes place the zygote may be inferior / fails to develop; however if the zygote develops the offspring may be inferior or sterile.

9. a) It is the emergence of present forms of organisms gradually from pre-existing ones some of which no longer exists).
- b) It is the drifting apart of the continents from one land mass (Pangaea).
- 10.
- a) When organisms of the same origin become adapted (modified) in different ways in order to fit in the environment. The organisms are separated due to natural factors.
- b) When an organism is exposed to drug for sometime it becomes modified (adapted) to living in presence of the drug. The offspring produced therefore survive in presence of the drug. Hence drug resistant.
11. a) Homologous structures – structure / organs that have arisen from a common but they have assumed different functions
- b) Analogous structures – Structures/organs that have originated from different ancestors but they perform the same function.
12. a) Natural selection is a process where nature selects those organisms that are well adapted to the prevailing environmental conditions enabling them to survive to reproductive maturity. Those organisms that are poorly adapted die young leaving no offspring and their characteristics are eventually eliminated from the population.
- b) Mutation brings about new hereditary characteristics (or hereditary variation) in a species. Some of the new characteristics are favourable but others are unfavorable. Favourable characteristics enable the organism possessing them to compete better in the struggle for existence. The result is that most of them

survive to adulthood and give rise to offspring of the next generation. Since characteristics resulting from mutation are inheritable they are passed on to new generation. On the other hand, only very few of those organisms with unfavorable characteristics survive to adulthood and give rise to young ones. The final result is that the favourable characteristics are propagated in the population giving rise to organisms that are better adapted to the environment. The unfavorable characteristics are gradually weeded out and may eventually get eliminated from the population.

- 13.(a) A hybrid is an offspring of across between different varieties or breeds of the same species.
- (b) Hybrid vigour refers to the improved qualities, such as increased yields, fertility, resistance to diseases and toughness seen in offspring of different.

14. The peppered moth usually on trunks and branches of trees, industrial cities, tree trunks and branches are normally dark in colour due to deposits of soot and other pollutants. A white moth resting on such a trunk or branches is highly conspicuous and is easily picked and eaten by preying birds. A dark moth resting at the same places is effectively camouflaged by the dark background and is not easily seen by preying birds.
- In rural areas, tree trunks and branches are normally white in colour due to growth of lichens. A white moth resting on such a trunk or branch is effectively camouflaged by the white background and is not easily seen by preying birds. A dark moth resting at the same place is highly conspicuous and is easily picked and eaten by preying birds.
 - Therefore, dark moths are adapted for survival in industrial areas. Here most of them reach maturity and reproduce more dark moths. On the other hand, only a few white moths survive to maturity and reproduce in industrial areas. In rural areas, most white moths survive to maturity and reproduce more white moths. Here only a few dark moths survive to maturity and reproduce.
15. (a) Special creation is a concept which proposes that all living things were made by God at a specific time and have remained unchanged since.
- (b) Organic evolution is a concept which proposes that all living things arose from a few ancient simpler forms through gradual modification.

CHAPTER 3

RECEPTION, RESPONSE & CO- ORDINATION

1. **Structural difference**- the cell body in motor neurone is terminal (at the end) and inside the central nervous system. While the cell body in sensory neuron is not terminal but has axon on both end i.e. bipolar.

Functional differences – motor neurone carries impulses from CNS to the effectors i.e. muscles, while sensory neurons carry impulse for receptor to CNS.

- 2.

Hormone	Site of production	Function
Oestrogen	Ovary	Initiate and control development of secondary sexual characteristics
Aldosterone	Adrenal gland	Mineral reabsorption

3. (i)

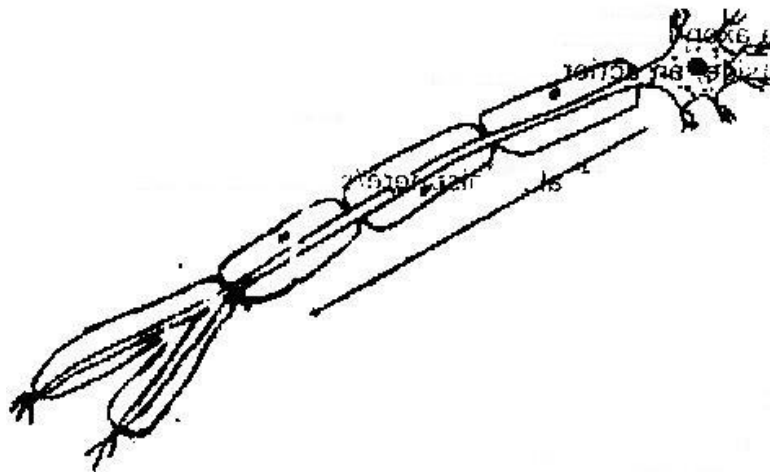

(ii) P- Protection/ insulation

Q- Impulses transmitted/depolarization is faster.

4. (a)

Adaptation	Function
Conjunctiva - An epithelium colourless	Protects eyeball
Cornea: Transparent/curved	Allow light/ refract light entering the eye
Aqueous/vitreous: clear	Allow light to pass through/ refract light. Maintain the shape of the eye
Iris. Opaque and contractile	Controls light intensity/amount of light entering the eye.
Ciliary muscle/ body contractile	Control curvature of lens, secretes humour
Suspensory ligaments: are fibrous	Hold lens in position
Lens is transparent; lens is biconvex	To allow light to go though/to refract light/ to focus light.
Retina- contain light sensitive cells	Where an image is formed which perceive light.
Cones: contain pigments	For colour vision/ bright light/ light of high intensity
Rods contain pigments	For dim light vision
Forea centralis: High concentration of cones	For accurate vision

Choroid: Layer has blood vessels	For nutrition and pigments. Reduce light reflection and absorb stray light
Sclera- Tough/ non elastic or fibrous	Gives eye shape and protects
Optic nerve	Contain sensory neurones for transmitting impulses from retina to brain.

(b)

Defect	Correct
Myopia/ short sightedness	Biconcave/diverging lenses
Hypermetropia/long sightedness	Biconvex/ converging lenses
Astigmatism	Use of cylindrical lenses with combined curvature

5. When an impulse passes along the axon, the membrane of the axon becomes depolarized to sodium ions to diffuse into the axon; the inside of the axon becomes positively charged relative to the outside, an action potential is generated.
6. Cerebrum/ cerebral hemisphere/ cerebral cortex
7. (a) B- Cerebellum
C- Medulla oblongata
- (b) - Control locomotion
 - Control voluntary movement
 - Vision/ hearing/ smell/ taste
 - Intelligence/ memory

- Personality speech
 - Mediates cranial co-ordination
- (c) Loss of muscle coordination/ balance
8. (a) Cones- Discrimination of colour/ sensitive to high light intensity / bright light.
- (b) Rods- Dim light vision/ low light intensity
9. (a) (i) -Receive sound waves
- Transforms sound waves into vibrations
 - Transmit vibration to the ear ossicles
- (ii) Equalizes the air pressure in the middle ear to that in the outer ear.
- (iii) Amplify/ transmit vibrations from the tympanic membrane in the inner ear.
- (b) There are three semi- circular canals arranged in a plane at right angles to each other. At the end of each canal is a swelling called ampulla which contains receptors.
- Movement of the beat cause movement of the fluid in at least one canal/ the fluid movement deflect the cilia and stimulate the receptors/sensory hairs. Nerve impulses are transmitted to the brain by the auditory nerve.
10. The organisms move towards light so as to absorb it for photosynthesis.
11. (a) Thigmotropism
- (b) -That part of plants is offered support
- The leaves become more exposed to sunlight increasing photosynthesis.
 - Flowers become exposed to pollinating agents.
- 12.

- (a) X- Motor neurone
Y- Receptor
 - (b) Acetylcholine
13. (a) Alter the shape of the lens during accommodation
- (b) - Rods- sensitive to dim light
 - Cannot distinguish colour
 - Cones- Sensitive to colour
 - Enhance high clarity of vision
14. (a) Ear ossicles Magnify sound wave vibrations from the ear drum
- (b) Cochlea Receives sound vibrations from the oval window and transmits into the auditory nerve.
 - (c) Semi- circular canals Structures that help maintain body balance
 - (d) Eustachian tube Enhance equalizing of pressure between outer and the middle ear.
15. (a) In the central nervous system (spinal cord)
- (b) (i) Motor neurone
 - (ii) P – Dendrites
Q- Axoplasm (Axon)
 - (c) Insulates the axon
16. (a) Auxin
- (b) Growth response due to touch of a part of a plant e.g. tendrils
17. The ear is an organ involved in perceiving sound and maintaining body balance and posture. It is made of the following sections.

- Pinna- That is funnel shaped structures made of skin and cartilage. It receives sound waves and directs them to the ear tube.
- External /auditory meatus- That is a canal lined with hair and wax. It allows passage of sound waves to the middle ear. The hairs and wax trap dust particles that enter the ear.
- Tympanic membrane that is a thin flexible sheet-like structure receives sound waves and passes the vibration to the ossicles.
- Middle ear that is composed of:
Tiny bones known as ossicle. They are stapes, anvil and incus. They amplify vibration from the tympanic membrane.
- Eustachian tube that connects the ear to the nasal cavity. It balances pressure on both sides of the tympanic membrane.
- Oval window that is a thin flexible membrane that opens into the inner ear. it receives vibrations from the ossicles and passes them to the inner ear.

Inner ear that is composed of:

- Vestibular apparatus that are the semi circular canals, utricles and the saccules. They help in maintenance of body balance and posture.
 - Cochlea that is a coiled structure that has sensory cells for hearing. It is connected to the auditory nerve that is involved in transmission of sounds to the brain.
18. - Presence of rods having rhodopsin pigment that is sensitive to dim light.

- Rods are more sensitive to motion and easily notes movement from the cornea of the eye.
- More than 120 million rods present on the retina.

19. Perceive sound waves.

Maintain body balance and posture.

20.

Response of human eye	Response of flowering plant
<ul style="list-style-type: none"> • Quick response • Does not result to growth • Mediated by nerve impulses and brain • The response is not permanent 	<ul style="list-style-type: none"> • Slow response • Results to growth • Mediated by growth hormones (auxins) • Response is more permanent

21. (i) Thigmotropism

(ii) Auxins on the stem are sensitive to touch. They migrate to opposite side.

Growth is more on the touched side. This causes bending.

(iii) Have more chlorophyll to trap sunlight

- Have stomata for entry of carbon dioxide.
- Thin and transparent cuticle to allow entry of light into the photosynthetic cells
- Presence of veins for transportation of raw materials to the leaf or food for the leaf.

22. Euglena have chlorophyll and are autotrophic. They move towards light source

(positive phototactic) to absorb sunlight for photosynthesis.

23. Acetylcholine is a chemical substance present at the synaptic knob. When a nerve impulse reaches the synapsis, acetylcholine forms in vesicles moving to the membrane.
24. In the spinal chord.
25. - Tar is deposited on parts of the respiratory tract causing cancer.
- Hardening the blood vessels and can cause heart attack.
- Irritation of the respiratory tract resulting to frequent coughing.
- Smoke can cause air pollution.
26. (i) Cones on retina.
(ii) Vitreous humour.
(iii) Suspensory ligaments.

CHAPTER 4

SUPPORT AND MOVEMENT IN PLANTS AND ANIMALS

1. (a) K - Facet for articulation, with the next vertebra
L - Transverse process for attachment of muscles
- (b) Cervical or neck region
2.
 - Skeletal muscles have actin and myosin which facilitate contraction and relaxation.
 - High density of mitochondria to provide energy for contraction.
 - Elongated fibres to allow change in length
3. (i) Ball and socket joint
- (ii) Biceps (flexor muscles) relax triceps (extensor muscles) contract.

4.

	Biceps	Gut muscles
(i)	Striated	Un- striated
(ii)	Multinucleated	Un- nucleated
(iii)	Long fibre cylindrical	Short fibred Spindle shaped

5. (a) Femur
- (b) Ball and socket joint
6.
 - a. Attachment of powerful back muscles
 - b. Maintain posture

- c. Maintain flexibility of vertebral column
7. (a)
- a. Hydrostatic
 - b. Exoskeleton
 - c. Endoskeleton

(b) Cervical vertebrae

- Presence of vertebrarterial canal for passage of vertebral artery. Atlas had (broad) surfaces, for articulation with condyles of skull to permit nodding
- Axis has odontoid process/ projection Centrum to permit rotary/ turning. Act as a pivot for atlas.
- Branched/ forked/ short and broad transverse processes for attachment of neck muscles
- Presence of zygapophysis for articulation between vertebrae
- Has short reduced neural spine for attachment of neck muscles. Has wide neural canal for passage of spinal cord and protect it.

Lumbar

- Broad / long neural spine for attachment of powerful back muscles.
- Large and well developed transverse processes for attachment of muscles
- Has metamorphosis and hypophysis for muscle attachment. Large thick centrum for support.
- Prezygapophysis and post zygapophysis present for articulation between vertebrae

Sacral vertebrae

- Interior has well developed transverse processes which are fused to the pelvic girdle.
- Vertebrae fused for strength transmit weight of the stationary animal to the rest of the body
- Sacrum has a broad base/ short neural spine for attachment of back muscles

8.

- (a) Ulna
- (b) Radius
- (c) Humerus

9.

- (a) Inter- vertebral discs/ Fibro cartilage
- (b) Absorb shock and reduce friction between the bones

10. Side walls have deposition of lignin to strengthen them

11.

- (a) Y- Femur
Y- Tibia
Z- Fibula
- (b) (i) Synovial fluid
(ii) Absorb shock/ reduce friction between joints
- (c) Ligament
- (d) Ball and socket – allow movement in all direction

Hinge joint- Allow movement in one plane only

- (e) Sigmoid notch

12.

- (a) Have short neural spines

- (b) - Xylem tissues
- Collenchymas tissues
- Sclerenchyma tissues
- Parenchyma tissues

13. (a)

Type of muscle	Where found
(i) Skeletal	Attached bones and skeleton
(ii) Smooth	Walls of tubular structures
(iii) Cardiac	Heart muscles

- (b) Ball and socket joint – allows movement in all directions i.e 360°
Hinge joint- Allows movement only on one plane i.e 180°
- (c) It is a slippery fluid that lubricates the joints reducing friction during movement.
- (d) - Prevents drying out of organism
- Controls size of the organism
- Provides protection against microbial infections and mechanical injury.

14.

- a. Support and protects inner delicate tissues

- b. Prevents excessive loss of water from body tissues
- c. Provides surfaces for muscle attachment.

15.

- (a) Dorsal fin – Prevented rolling or yawing
- (b) Pectoral and pelvic fins- used for steering and prevent pitching
- (c) Caudal fin – steering and forward propulsion

16.

- a. Contract spontaneously and do not fatigue.
- b. Innervated by the autonomic nervous system
- c. Contractions are initiated from within the muscles
- d. They are myogenic

17. (a)

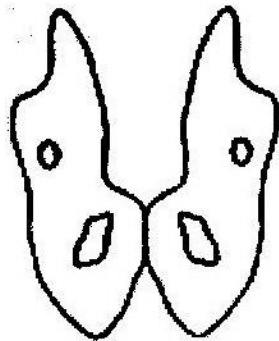

- c) Femur – Articulates with acetabulum
- Sacrum – articulates with ilium

18. Tendons – Tissues between muscles and bone in a joint

Ligaments – Tissues between bone and another bone in a joint

19. They are muscles that contract while the others relax e.g triceps and biceps muscles.

20. (a)

- Xylem vessels
- Collenchyma
- Sclerenchyma

(b) Xylem- lignified on the side walls

Collenchyma – thickened by deposition of cellulose and pectic compounds

Sclerenchyma – lignified on the cell walls.

21. (a) - Immovable joints

- Synovial (movable) joints)

- Gliding/ sliding joints

(b) - Immovable joint – Cranium / skull

- Synovial joint – between limbs

- Gliding / sliding joint- vertebral column

22. - Turgidity of the parenchyma cells

- Presence of collenchyma tissues

23. **Skeletal muscle**

a. Attached to the skeleton

b. They are striated/ fibres that allow contractions

c. Presence of mitochondria to provide energy for contractions

d. Have antagonistic contractions to enhance movement

Cardiac muscle

- a. They are the heart muscles
- b. Highly connective tissues to allow harmonious contraction
- c. They do not fatigue
- d. Ends are intercalated to transmit impulses throughout the heart

Smooth muscle

- a. Walls of tubular organs
- b. Capable contracting slowly
- c. Innervated by autonomic nervous
- d. System/ involuntary movement

PAPER 1

1. (a) Flagellum
(b) Cilia
2. (a) Genes located on sex chromosomes and are transmitted along with them
(b) Colour blindness, hairy pinna, haemophilia, baldness
3. (a) Genus - Bidens
(b) Species- pilosa
4. (a) Carbon (IV) Oxide
- Uric acid
(b) Oxygen, gum, carbon (IV) Oxide
- Tannins, quinine water vapour, latex
5. - Small and light to be carried easily by wind
- Have hair- like structures or floss to increase buoyancy in the air
- Develop wing- like structures or floss to increase surface area for increased buoyancy in the air
6. The pollen tube directs the male nuclei or gametes into the ovules in the embryo sac.
- 7.

DNA	RNA
a. Double stranded	a. Single stranded
b. Deoxyribose sugar	b. Ribose sugar
c. Thymine base	c. Uracil base
d. Less oxygen molecules	d. More oxygen molecules

--	--

8. (a)

Meiosis	Mitosis
a. Takes place in reproductive cells	a. takes place in body cells
b. Division are double (I and II)	b. division is only one
c. Daughter cells are identical to parent cell (Diploid)	c. daughter cells are not identical to parent cells (Haploid)
d. Homologous chromosomes associate	d. Homologous do not associate
e. Four daughter cells formed	e. Two daughter cells formed
f. Chiasmata formed and crossing over occur	f. Chiasmata not formed and there is no crossing over

- (b) - DNA replicates
 - Cell organelles replicate
 - Cells build up a store of energy to carry out the division process through to the end

9. - Oviduct
 - Trachea or tracheal epithelium

10. (a) A- Epidermal cell
 B- Guard cell

- (b) Carbon (IV) Oxide

(c) - Thick inner wall and thin outer wall to control the opening and closing of them.

- Presence of chloroplasts to carry out photosynthesis

11. - Human

- Mosquitoes

12. Female – Ovaries

Male - Testes

13. - Are brightly coloured to attract animals

- Have a sweet scent to attract animals

- are succulent, juicy and edible

- Have seeds that resists egestion of enzyme

- Have hooks for attachment on the body of animals

14. (a) Aerobic respiration, mitochondria

(b) R.Q = Carbon (IV) Oxide produced

Oxygen used

$$= \frac{18}{26} = 0.692 = 0.7$$

26

(c) Lipid/ fat

15. - Has villi and micro villi

- Long length

16. (a) A- Synaptic Knob

B- Synaptic cleft

(b) C- Transmits impulses

17. It prevents the formation of solutions which would otherwise interfere with osmotic pressure of the tissues

18. (a) Cotyledon pushes above the ground

(b) Shoot pushes above the ground but cotyledon remains underground.

19. Assimilation is the process by which the body uses up the absorbed products by which the end products of digestion are taken into the epithelial cells of the ileum by diffusion or active transport.

20. - Regulation of blood glucose

- Regulation of amino acids

- Excretion of cholesterol and bile

- Production of heat

21. Lactic acid fermentation is the breakdown of glucose in a limited supply of oxygen in muscle tissues while alcoholic fermentation is the breakdown of glucose in absence of oxygen in plant tissues.

22. Water logging reduces the oxygen concentration in the soil hence plants die due to lack of oxygen for respiration.

23. - Plasmolysis occurs when plant cells are placed in hypertonic solution.
They lose water by osmosis and shrink.

- Haemolysis occurs when red blood cells are placed in hypertonic solution.
They absorb water by osmosis swell and burst.

24. Father X^HY

Mother H^YX^Y

25. A- Collenchyma- provides support for the stem

B- Sclerenchyma – provide mechanical support for the plant

C- Parenchyma- for support and storage of food

D- Xylem- transports water and minerals salts from the roots to other to parts of the plant, also gives support to the plant

26. (a) AIDS- Human immunodeficiency virus

(b) Bilharzia- Schistoma mansoni or Schistoma spp

(c) Cholera- Vibrio cholerae

27. Lungs, gills, skin, buccal cavity, book lung or tracheole.

28. - Production of food

- Production of oxygen

- Removal of carbon (IV) Oxide from the air.

29. (a) Continental drift- the drifting apart of the continents from one land mass called Pangaea. Pangaea split to form Gondwana and Glaurasia which further split into different continents.

(b) Fossils are the remains of organism that lived long ago which have been preserved naturally in the earth's crust.

30. Phototropism

PAPER 2

1. Genes being carried together on the same chromosomes and inherited and inherited together.

(b) (i)

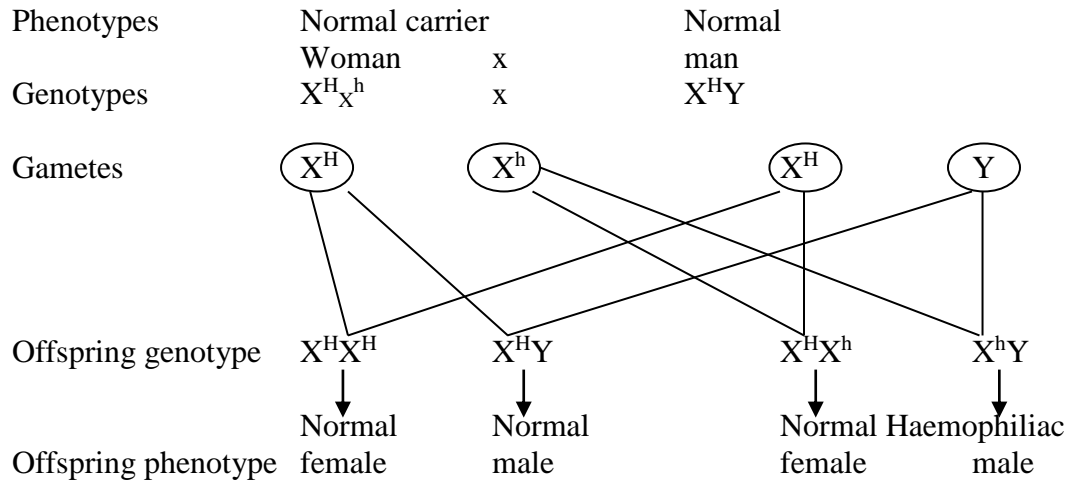

(ii) Male requires only one recessive allele to be a hemophilic while the female require two recessive alleles to be hemophilic.

(iii) Red- green colour blindness/ hairy nose and ears

2. (a) (i) $4.0 - 0.04 = 3.96\%$

(ii) Oxygen – exhaled air contains less oxygen because some of the oxygen in inhaled was used up for respiration.

Carbon (IV) oxide: exhales air contains more CO_2 produced during metabolism/ respiration.

Nitrogen – No inhaled nitrogen is used up in the body.

(b) - Have stomata on their surfaces

- Have thin cuticle which allows for diffusion of gases

- Have spongy mesophyl layer with air spaces to increase ventilation.

3. (a) X- Nitrifying bacteria

Y- Denitrifying bacteria

(b) Nitrogen gas

(c) A- Assimilation

B- Consumption

C- Nitrifying

4. (a) kkkk

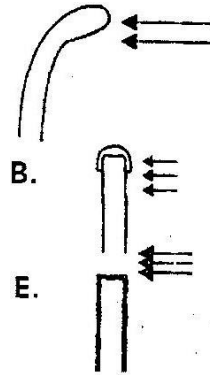

NB: No change in size E

(d) Auxins produce at the tip, migrate to the shaded side promoting faster growth on that side resulting to a grown curvature towards light.

(e) Set up B and C are control experiments showing it's the short tip that produces auxins that promotes phototropism.

5. (a) Process whereby fertilization takes place inside the body of the female.
- (b) - Pose health risk to the pregnant animals e.g. during birth the mother may die due to excessive bleeding.
- Pregnant animals is vulnerable to predators
- Its too demanding to the mother in terms of nutrients.
- (c) - Secrete hormones/ endocrine gland
- Medium for gaseous exchange
- Medium through which nutrient are supplied to the foetus

- Medium through which waste products are removed from the foetus.
 - (d) (i) - Causes Graafian follicle to develop in the ovary
 - Stimulate ovary to secrete oestrogen hormone
 - (ii) - Healing and repair of uterine wall after menstruation
 - Stimulates the pituitary gland to secrete oestrogen hormone
 - (iii) - Cause ovulation
 - Stimulates the corpus luteum to secrete progesterone hormone.
6. (a) Graph of the rate of growth of growth of femur and head.
- (b) (i) Intermittent growth/ discontinuous growth
- (ii) Phylum arthropoda
- Reason: Shows continuous growth/ intermittent growth.
- (c) (i) Length of femur remains constant/ no change in length; growth has not taken place because of the presence of rigid exoskeleton/ cuticle which limits expansion of tissues.
- (ii) Length of femur increased because moulting/ ecdysis/ shedding of exoskeleton has occurred allowing growth/ expansion of tissues.
- (d) - Juvenile hormone
- Moulting/ ecdysone hormone.
7. - Soil particles are surrounded by a film of water
- The cell sap of the root hair is more concentrated than soil water.
- Cell membrane of root hair acts as a semi- permeable membrane.

- Due to the concentration difference between cell sap and water in the soil water moves into the root hair by osmosis.
- This reduces the concentration of the cell sap in the root hair hence water moves into neighbouring cells (by osmosis). This continues through cell sap to cell sap; Cytoplasm and through intercellular spaces.
- Minerals are absorbed by either diffusion or active transport.
- Diffusion occurs where a concentration gradient exist/ concentration of mineral salts is more in soil water than in cell sap of root hair.
- Once in the xylem water moves up the plant aided by narrowness of the xylem vessels/ capillary; root pressure; attraction of water molecules to each other/ cohesion attraction of water molecules to the walls adhesion.
- From the stem xylem water enters the xylem of the leaves
- Once in the leaves water enters the mesophyll and by osmosis moves from cell to cell until it reaches the sub-stomatal chamber, where it evaporates into the air creating a transpiration pull.

(Total marks 25, max marks 20 marks)

8. (a)
- Secretion is discharge of useful substances such as hormone and enzymes.
 - Excretion is the elimination of waste products of metabolism
 - Egestion is the removal of indigestible and undigested materials from the alimentary anal.

- (b)
- Has renal artery to supply blood rich in metabolic wastes.
 - Has renal vein that drains purified blood from the kidney
 - Renal artery branches into arterioles that serve individual nephrons
 - Efferent arteriole is narrower than the afferent arteriole to create high pressure required for ultra filtration.
 - Glomerular capillaries are very narrow to create high pressure to enhance ultra filtration.
 - Has a capsule barrier that selectively allows some substance to pass through.
 - Has convoluted tubule that is highly coiled to slow down rate of flow of filtrate to allow more time for re-absorption.

PAPER 3

1. (a)

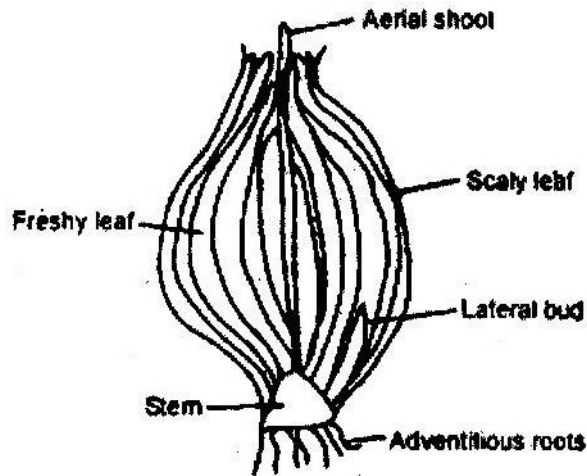

(b) (i)

Food	Procedure	Results	Conclusion
Starch	Place about 3 drops of extract on a white tile. Add a few drops of iodine solution	Yellow colour of iodine remains	Starch absent
Reducing sugars	Place about 2 cm ³ of extract in a test-tube and a few drops	Colour turns from blue to green yellow orange, orange then red- brown.	Reducing sugars present

(iii) When food is manufactured by the green aerial leaves it is then transported into the fresh leaves and stored for future use and development of new lateral buds.

- (c) (i) - Distilled water – the stalks were firm and more elongated. The water is Hypotonic and water is absorbed by osmosis into the cells which become turgid.
- 20% salt solution – the stalks were flaccid and shrunk.
 - The salt solution is hypertonic and water is absorbed by osmosis and they become flaccid.
 - Extract- The stalks remained size as the original. The extract is isotonic to that of the cell sap water moves in and out of the cells freely and turgidity of the cells is not affect.
- (ii) Help in support of plant by maintaining turgidity of the cells
- (d) - Have outer scaly that protect inner delicate parts.
- Have fresh leaves that store the manufactured food.
 - Stem holds the bulb firmly into soil.
 - Adventitious roots absorb water and minerals.

2.

Leaf	Step followed	Identity
P	1a, 2a	Hibiscus
Q	1b, 4a	Nandi Flame
R	1a, 2b, 3a	Mango
S	1b, 4b	Bean
T	1a, 2b, 3b	Morning glory

3. (a) Phylum - Arthropoda
- Reasons - Segmented body
- Jointed limbs
- Bilateral symmetry
- Has exoskeleton

- (b) Class - Insecta
- Reasons - Three body parts
- A part of compound eyes
- Three pairs of walking legs
- Two pairs of wings

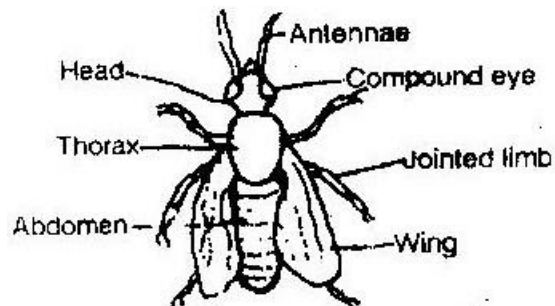

(c)

Specimen B	Man
a. Has exoskeleton	a. Has endoskeleton
b. Body has three body parts	b. Body compact having head, trunk and limbs.
c. Presence of wing	c. Closed circulatory system
d. Open circulatory system	d. Absence of antenna
e. Presence of antennae poikilothermic	e. Homeotherms

- (d)
- Dorsal ventral streamlined in order to fit in the small thin cracks
 - Exoskeleton is dark in order to be camouflaged against the dark background.
 - Wings aligned to the smooth exoskeleton in order to reduce friction when moving in the cracks.

PAPER 231/3

1. (a) J1 and J2 Rosales/ dicotyledonae
Reason Net veined/ net venation/ reticulate venation / two cotyledons
K1 and K2 Graminales/ monocotyledonae
Reason Parallel veined/ parallel venation/ one cotyledon/ fibrous root system.
- (b) (i) Hypocotyle
(ii) -Protect the plumule/ shoot tip/ first foliage leaves
-Opens space through the soil for cotyledons out of the soil.
- (c) Exposure of curvature to light, Auxins migrate to lower side. Faster growth of cells on that lower side, hence stem straightens.
- (d) Plumule sheath/ coleoptile
- (e) (i) J1 and J2
(ii) Root nodules
(iii) Rhizobium/ bacteria
(iv) Symbiotic
- (f) (i) Cotyledons/ seeds leaves
(ii) -Photosynthesis
-Stores food/ food reserve
- (g) (i) Hypogeal
(ii) Remains of grains/ cotyledons remain underground.
- (h) -Tap root (system)

-Fibrous toot (system)

2. (a) M - Trachea/ windpipe/ part of piece of trachea.
 N - Lung/ piece or part of lungs
- (b) Specimen M - Neck/ neck. Region/ throat/ cervical region
 Specimen N - Thoracic region/ chest cavity/ thorax/ chest/ Rib cage
- (c) M is a passage/ leads air into N Both M and N are part breathing structures/ breathing system/ respiratory system.

Specimen	Features	How features adapts specimen to its functions
M	(i) Rigid/firm cartilage (ii) Hollow/ tabular trachea/ lumen (iii) Elastic muscles (iv) Mucus lining surface (v) Moist surface	- Prevents collapsing keeps it open - Allow passage of air - Cause movement / allow for compression and flexibility - Top trap foreign bodies/ filter the air (Bacteria, dust etc) - To moisten the air.
N	(i) Spongy/ porous/ soft/ air sacs/ air spaces (ii) Elastic tissue (iii) Vascularized (iv) Moistened surface (v) Bronchioles (vi) Pleural membrane	- Increase surface area for gaseous exchange/ store air. - Allow for stretching / expansion - Facilitate transport of gases. - Air passage into and out of the lungs - protection/ reduces friction

3. (a) (i) Specimen Q- Lumbar vertebrae

Reasons

1. Large / broad Centrum
2. Long/ broad transverses processes
3. Presence of metamorphosis
4. Presence of anapophysis
5. Broad/ wide neurospine

(ii) Specimen R- Cervical vertebrae

Reasons

1. Pointed/ short/ small neural spine
2. presence of vertebral/ canals
3. Winged/ forked/ branched/ divided transverse processes
4. Presence of cervical ribs

- (b) - Presence of neural canal for passage of spinal cord
 - Neural spine for attachment of muscles
 - Has facets for articulations with other vertebrae
 - Vertebral canals for passage of blood vessels
 - Has neural arch and Centrum for protection of the spinal cord.

(c)

Q	R
a. Vertebral canal absent	a. Vertebral canal presence.
b. Large, unbranched transverse processes	b. Small, forked/ branched transverse processes.
c. Broad/ large neural spine	c. Neural spine small/ narrow
d. Narrow neural canal	d. Wide neural canal

e. Presence of metapophyses or anapophyses	e. Absence of metapophyses or anapophyses
--	---

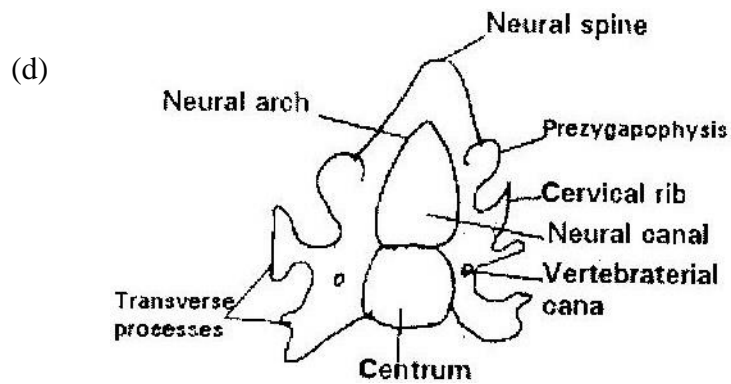

Drawing marks

D1 Complete outline and proportionality

Proportionality = size of Centrum to be smaller than neural canal

D2 Branched Transverse processes. Vertebrarterial canals properly drawn- near the point where neural; arch and Centrum comes into contact.

D3 Centrum and neural spine properly drawn.

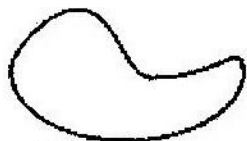

Centrium



Neural spine

BIOLOGY PAPER 3

1. (a) Vertebral column
 - (b) K - Atlas
M - Axis
N - Cervical vertebrae
 - (c) - Wing – like transverse processes/ broad transverse process
- No centrum
- Presence of vertebral canal
- Reduced neural canal
- Wide neural canal
 - (d) Odontoid process
Spinal cord
 - (e) S (facet) - Articulate with axis
T - Passage of vertebral blood vessels and vertebral nerves
 - (f) Condyles of the skull
 - (g) U - Neural spine
Y - Odontoid process
R - Centrum
L₁ - distilled water
L₂ - Salty water
2. (a) (i) Become firm/ turgid – L₁
L₁ become flabby/ flaccid

(ii) L₁ – Hypotonic solution as compared to cell sap of cells. Gains water by osmosis and cell becomes turgid.

L₂- Solution hypertonic as compared to cell sap of cells/ Loses water by Osmosis become flaccid/ plasmolysed.

(b) (i) L₁ Bend curvature from the cut surface

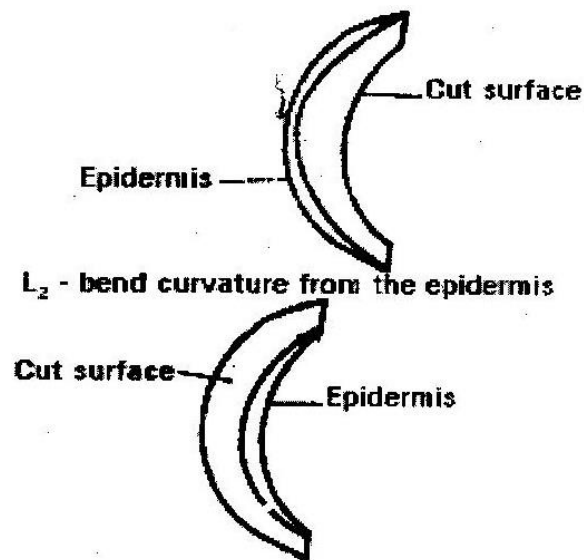

(ii) The cuticle prevented water from being absorbed by cells (it is water proof)

3. (a) Set A - normal condition

Set B - in the dark

Set C - in the dark with unilateral / source of light

(b) A B

- Green leaves

- Yellow leaves

- Short internodes - Long internodes
- Strong stem - Weak stem
- Broad leaves - Small leaves

- (c) (i) Etiolation
- (ii) Grows tall/ long in an attempt to reach light.

- (d) Positive phototropism

- (e) Auxins diffuse on the side away from light result to more cell division
 (more growth on that side resulting to bending towards light.

BIOLOGY

Paper 1

1. Name the tissues in plants responsible for:
 - (a) Transport of water and mineral salts
 - (b) Transport of carbohydrates
 - (c) Primary growth (3 marks)

2. State the importance of the following processes that take place in the nephrons of a human kidney:
 - (a) Ultra filtration (1 mark)
 - (b) Selective reabsorption (1 mark)

3. (a) Name a disease of the liver whose symptom is jaundice (1 mark)
(b) State the causative agent of:
 - (i) Cholera (1 mark)
 - (ii) Candidiasis (1 mark)

4. The diagram below show a red blood cell that was subjected to a certain treatment

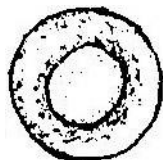

At start



At the end
of experiment

- (a) Account for shape of the cell at the end of the experiment (2 marks)
- (b) Draw a diagram to illustrate how a plant cell would appear if subjected to the same treatment. (1 mark)
5. (a) State two factors that effect enzymatic activities. (2 marks)
- (b) Explain how one of the factors stated in (a) above affects enzymatic activities (2 marks)
6. (a) What is meant by non- disjunction? (1 mark)
- (b) Give two examples of continuous variations in humans (2 marks)
7. (a) What is a fossil? (1 mark)
- (b) How does convergent evolution occur? (3 marks)
8. The diagram below shows a stage in mitosis in a plant cell



- (a) Name the stage of mitosis (1 mark)
- (b) Give two reasons for your answer in (a) above (2 marks)
- (c) Name the part of the plant from which the cell used in the preparation was obtained (1 mark)

9. Give three factors that determine the amount of energy a human requires in a day (3 marks)
10. (a) Name the antigen that determines human blood groups (2 marks)
- (b) State the adaptation that enables the red blood cells to move in blood capillaries (1 mark)
11. (a) What is homeostasis? (1 mark)
- (b) Name three processes in the human body in which homeostasis is involved (3 marks)
12. State two functions of the endoplasmic reticulum (2 marks)
13. (a) Name the part of the retina where image formed on the retina (1 mark)
- (b) State two characteristics of the image formed on the retina. (2 marks)
14. Describe the three characteristics of a population (3 marks)
15. Explain what happens when there is oxygen debt in human muscles (2 marks)
16. The diagram below represents a set up that was used to investigate a certain process in a plant

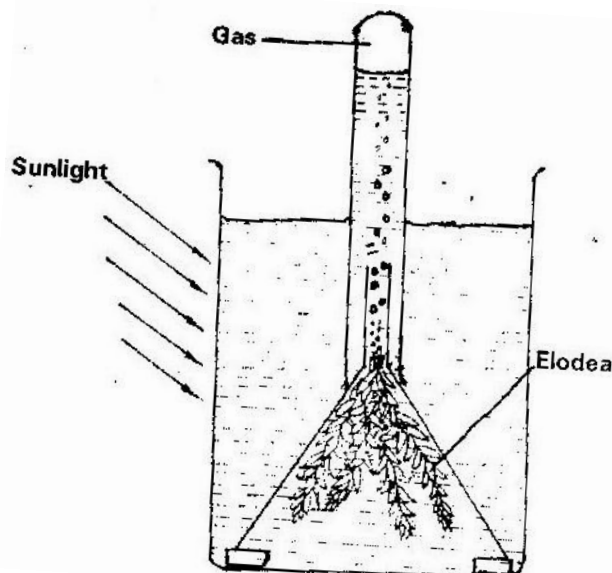

- (a) State the process that was being investigated (1 mark)
- (b) State a factor that would affect the process (1 mark)
17. Account for the following phases of a sigmoid curve of growth of an organism:
- (a) Lag phase (1 mark)
- (b) Plateau (1 mark)
18. How is the epidermis of a leaf of a green plant adapted to its functions?
(2 marks)
19. The diagram below represents a tissue obtained from an animal

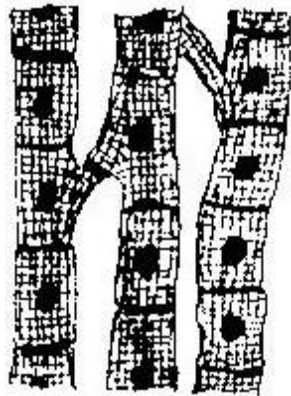

- (a) Identify the tissue (1 mark)
- (b) State the function of the tissue named in (a) above (1 mark)
20. (a) What is single circulatory system?
- (b) Name an organism which has single circulatory system (1 mark)
- (c) Name the opening to the chamber of the heart of an insect (1 mark)
21. (a) What is seed dormancy? (1 mark)
- (b) Name a growth inhibitor in seeds (1 mark)
22. State two characteristics of aerenchyma tissue (2 marks)

23. The diagram below shows a human tooth

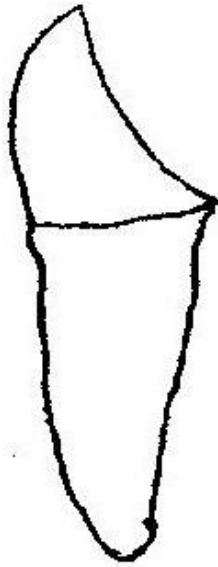

(a) Identify the tooth (1 mark)

(b) How is the tooth adapted to its function (1 mark)

(c) State the role of the following vitamins in human body

(i) C (1 mark)

(ii) K (1 mark)

24. Name the sites where light and dark reactions of photosynthesis take place

Light reaction

Dark reaction

25. Giving a reason in each case, name the class to which each of the following

organisms belong (4 marks)

Bean plant

Reason

Bat

Reason

26. State one use of the following excretory products of plants:

a. Colchicines (1 mark)

b. Papain (1 mark)

27. Explain how anaerobic respiration is applied in sewage treatment

(1 mark)

28. (a) State the mode of asexual reproduction in yeast (1 mark)

(b) Distinguish between protandry and protogyny (2 marks)

29. State a function of amniotic fluid (1 mark)

30. The diagram below shows two fused bones of a mammal.

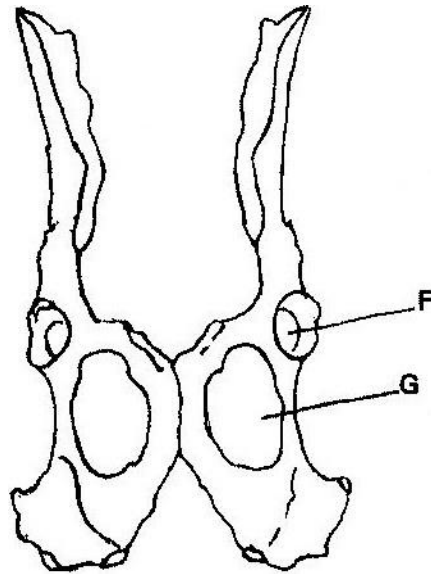

(a) Identify the fused bones (1 mark)

(b) Name the

(i) Bone that articulates at the point labeled F (1 mark)

(ii) The hole labeled G (1 mark)

BIOLOGY PAPER 2

SECTION A (40 Marks)

Answer all the questions in this section

1. The figure below shows changes that take place during menstrual cycle in human

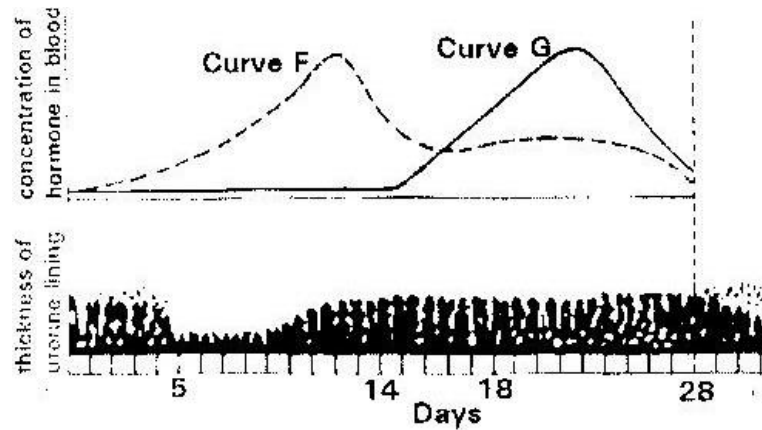

- (a) Name the hormones whose concentrations are represented by curves F and G
(2 marks)
- (b) State the effects of the hormones named in (a) above on the lining of the uterus
(2 marks)
- (c) (i) Name the hormone which is released by the pituitary gland in high concentration on the 14th day of the menstrual cycle.(1 mark)
- (ii) State two functions of the hormone named in (c) (i) above.
(2 marks)
- (d) State the fertile period during menstrual cycle. (1 mark)
2. A pea plant with round seeds was crossed with a pea plant that had wrinkled seeds. The gene for round seeds is dominant gene state
- (a) The genotype of parents if plant with round seeds was heterozygous
(2 marks)

(b) The gametes produced by the round and wrinkled seed parents

Round seed parent

Wrinkled seed parent

(c) The genotype and phenotype of F1 generation. Show your working

(3 marks)

(d) What is a test- cross?

(1 mark)

3. The equation below represents a process that takes place in plants

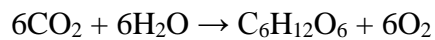

(a) Name the process

(1 mark)

(b) State two conditions necessary for the process to take place

(2 marks)

(c) State what happens to the end- products of the process

(5 marks)

4. (a) Give three reasons in each case why support is necessary in:

(i) Plants

(3 marks)

(ii) Animals

(3 marks)

5. A freely obtained dandelion stem measuring 5 cm long was split lengthwise to obtain two similar pieces.

The pieces were placed in solutions of different concentrations in Petri dishes for

20 minutes

The appearance after 20 minutes is as shown

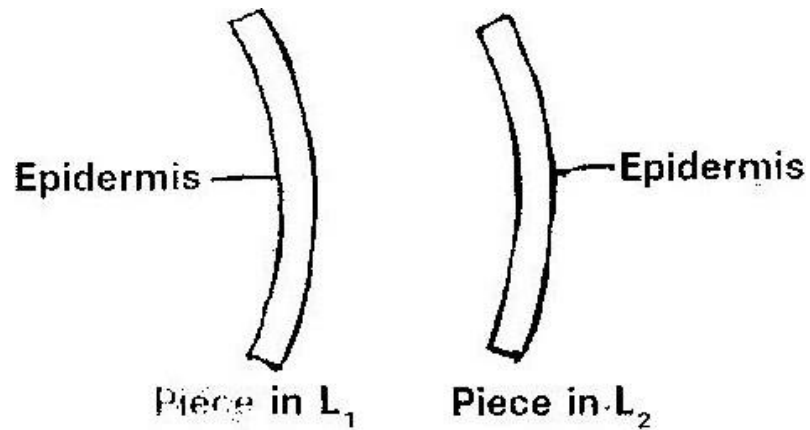

(a) Account for the appearance of the pieces in solutions L₁ and L₂ (6 marks)

L₁ _____

L₂ _____

(b) State the significance of the biological process involved in the experiment

(2 marks)

SECTION B (40 Marks)

Answer questions 6 (compulsory) and either questions 7 or 8

6. An experiment was carried out to investigate transpiration and absorption of water in sunflower plants in their natural environment with adequate supply of water.

The amount of water was determined in two hour intervals. The results are shown in the table below.

Time of day	Amounts of water in grammes	
	Transpiration	Absorption
11 00 - 13 00	33	20

13 00 - 15 00	45	30
15 00 - 17 00	52	42
17 00 - 19 00	46	46
19 00 - 21 00	25	32
21 00 - 23 00	16	20
23 00 - 01 00	08	15
01 00- 03 00	04	11

- (a) Using the same axes, plot graphs to show transpiration and absorption of water in grammes against time of the day (7 marks)
- (b) At what time of the day was the amount of water the same for transpiration and absorption? (1 mark)
- (c) Account for the shape of the graphs of:
- (i) Transpiration (3 marks)
- (ii) Absorption (3 marks)
- (d) What would happen to transpiration and absorption of water if the experiment was continued till 05 00 hours? (2 marks)
- (e) Name two factors that may affect transpiration and absorption at any given time (2 marks)
- (f) Explain how the factors you named in (e) above affect transpiration. (2 marks)
7. Describe the nitrogen cycle (20 marks)
8. (a) State four characteristics of gaseous exchange surfaces (4 marks)
- (b) Describe the mechanism of gaseous exchange in a mammal (16 marks)

BIOLOGY PAPER 3

PRACTICAL

1. Below is a photograph of a dissected mammal. Examine the photograph.

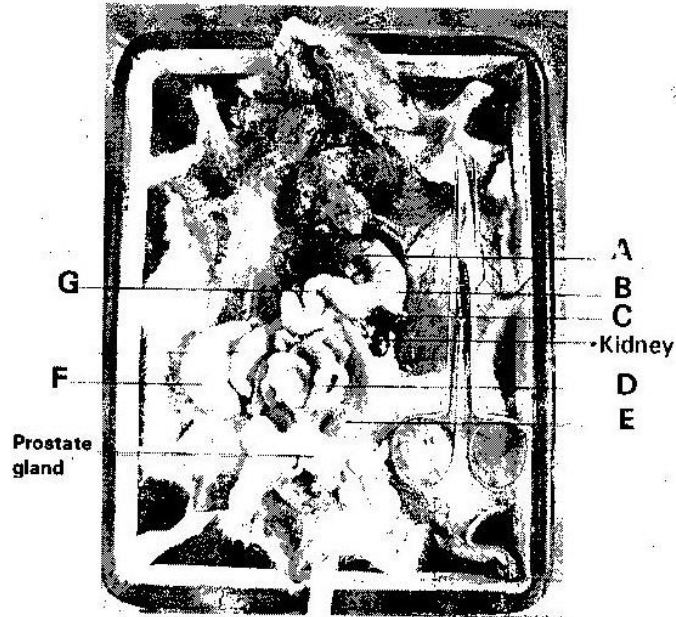

(a) Name the parts labeled A, B, C, D and G (5 marks)

A _____

B _____

C _____

D _____

G _____

(b) State the function of the structures labeled E and F

E _____ (1 mark)

F _____ (1 mark)

(c) In the photograph label the structure where vitamin K is produced

(1 mark)

- (d) (i) Name the sex of the mamma; in the photograph (1 mark)
- (ii) Give a reason for your answer in (d) (i) above (1 mark)
- (e) (i) The actual length of the dissecting scissors in the photograph is 5 cm. Calculate the magnification of the photograph (2 marks)
- (ii) Calculate the actual length of the mammal from the tip of the nose to point X on the tail (2 marks)

2. You are provided with substances labeled S, T,U X, and Y. S, T and U are food substances, while X is 10% sodium hydroxide solution and Y is 1% copper sulphate solution. Carry out tests to determine the food substance (s) in S, T and U. (9 marks)

Substance	Food substance being tested for	Procedure	Observations	Conclusion
S				
T				
U				

3. Below are photographs of specimens obtained from plants. Examine the photographs.

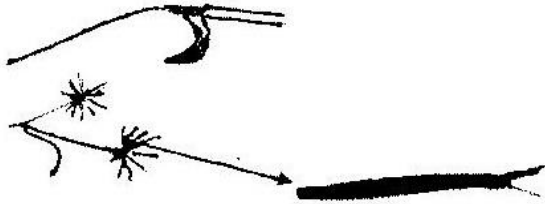

SPECIMEN K

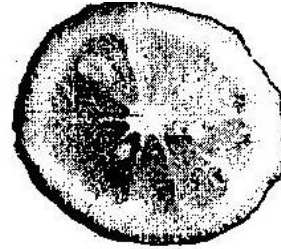

SPECIMEN L

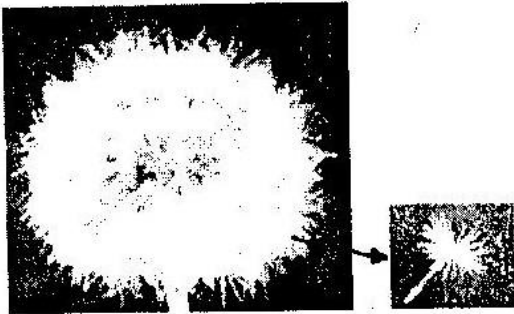

SPECIMEN M

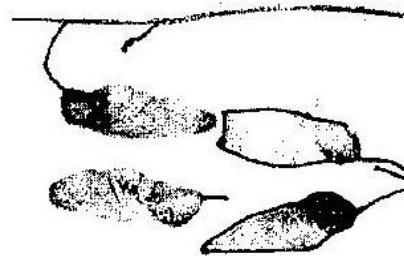

SPECIMEN N

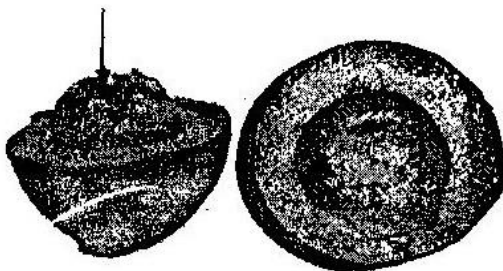

SPECIMEN P



SPECIMEN Q

- (a) In the table below name the mode of dispersal and the features that adapt the specimen (s) to that mode of dispersal (12 marks)

Specimen	Mode of dispersal	Adaptive
K		
L		
M		
N		
P		
Q		

- (b) (i) Label any two parts on specimen L (2 marks)
- (ii) State the type of placentaion in specimen L (1 mark)
- (c) Name the structure labeled W on specimen P (1 mark)

MARKING SCHEME

PAPER 1

1. (a) Xylem
 - (b) Phloem tissues
 - (c) Apical meristem
2. (a) Remove the soluble substances; both useful and waste products from the blood stream
 - (b) The reabsorb the useful substances that had been ultra filtrated and leave the waste products.
3. (a) Liver cirrhosis
 - (b) (i) *Vibrio cholerae*
 - (ii) *Candida vaginitis*
4. (a) The blood cell was placed in a hypertonic solution/ highly concentrated solution. It lost water to the surrounding by osmosis until it lost its shape and became crenated.

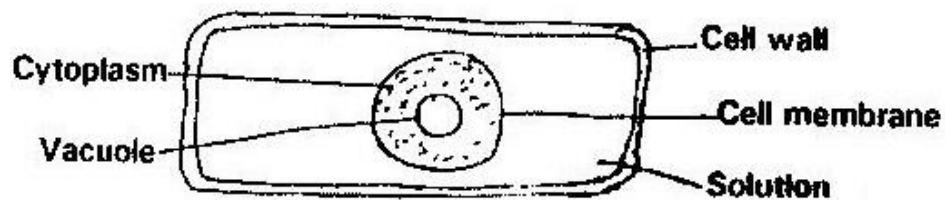

5. (a)
 - Temperature
 - pH value

- Enzyme concentration
- Substrate concentration
- Enzyme co- factors and co- enzymes
- Enzyme inhibitors

(b)

- Temperature – very low temperatures inactivate the enzymes. Very high temperatures denature the enzymes. Therefore the optimum temperature should be maintained for maximum enzyme activity.
- pH value- Some enzymes act best in acidic or basic medium. Therefore optimum pH value should be maintained for maximum enzyme activity.
- Enzyme concentration – when the enzyme concentration is increased the rate of enzyme activity also increases as long as there are enough molecules of the substrate.
- Substrate concentration – when the substrate concentration increases the rate of enzyme activity also increases as long as there are enough molecules of the enzymes. However further increase of the substrate may not increase the rate as all active sites of the enzymes will be occupied.
- Enzyme co- factors are the non- proteinous substances that activate the enzymes. Most enzymes will not work without the co-factors. They are metallic ions.
- The co- enzymes are organic non- protein molecule that work in association with enzymes. They are derived from vitamins.

- Enzyme inhibitors – they are substances that slow down or stop the enzyme activity if present. They fit into the active site of the substrate has no chance to fit into the active site.

6. (a)

- It is when the homologous chromosomes fail to segregate/ separate in anaphase resulting to one gamete or cell having more chromosomes and the other having less chromosomes

(b)

- Body height
- Skin colour
- Body weight
- Finger print types

7. (a)

- It is a remain of an ancestral form of an organism that has been accidentally preserved in a naturally occurring materials e.g. in sedimentary rocks.

(b)

- It is when structures from different origins become modified to perform similar functions.
- As a result of competition of resources and in order to exploit new habitats/ environments, the structures become modified to look similar and have similar function e.g. wings of insects, birds and bat.

8. (a)

- Early telophase

(b)

- The chromatids have moved and are very close to the poles
- Spindles fibres have disappeared

(c)

- Tip of root or shoot
- Flower when in form of bud
- A fertilized ovule developing into seed

9.

- Type of occupation
- Gender
- Age
- Body size
- Basal metabolic rate

10. (a)

- Antigen type A and antigen type B.

(b)

- They are small in size and can change their shape in order to fit in the pores of capillary walls.

11. (a)

- It is the maintenance of a constant internal environment of cells:

(b)

- Osmotic pressure regulation
- Temperature sugar regulation
- Ionic balance
- Blood sugar regulation

12. Rough endoplasmic reticulum – Transport substances (proteins) within the cell.

Smooth endoplasmic reticulum – Site of synthesis of lipids and destruction of foreign chemicals e.g. drugs.

13. (a) Forea centralis or yellow spot

- (b) - It is virtually inverted
- It is not a real image

14.

- Population density – The number of individual per unit area.
- Sex – Ratio – the number of males and females in an ecosystem
- Age structure – number of individuals in the reproductive age
- Birth and mortality rate- The number of births comparing to the number of deaths in the population
- Population growth – the rate of increase in the number of individuals of a species.

15.

- As a result of a vigorous exercise, anaerobic respiration takes place resulting to formation of lactic acid. It is toxic and causes muscle cramps.
- It therefore has to be broken down into carbon (IV) oxide and therefore extra oxygen has to be taken up for this process. The extra oxygen is oxygen debt.

16. (a) Photosynthesis
- (b)
- Sunlight
 - Temperature change
 - Carbon (IV) oxide concentration
17. (a) The cells are few and immature and have not yet started dividing rapidly.
- (b) There are very many cells present and the rate of death/ destruction of old cells is equal to the rate of formation of new cells.
- 18.
- It is transparent to allow light to penetrate through to the photosynthesis cells
 - The cells are packed from end to end preventing entry of micro- organisms and offering mechanical protection.
 - The cells secrete cuticle that is waxy and water proof preventing excessive water loss from the leaf.
 - Lower epidermis has specialized cells known as guard cells that control opening and closing of stomata.
19. (a) Cardiac muscle tissue
- (b) Contract and relax rhythmically enhancing the heart beat
20. (a) It is when the transport fluid flows from the heart once before passing through the oxygenating sites and body tissues then back to the heart.
- (b) Fish
- (c) Ostium
21. (a) It is a state when there is inactivity in a seed. Growth slows down or stops

completely.

(b) Abscisic acid

22.

- The cells are vertically arranged from end to end, from the upper epidermis to the lower epidermis.
- Large intercellular air spaces present

23. (a) Canine

(b)

- Long root to support it into the jaw bone
- Curved and pointed to tear the flesh/ meat

(c) (i) Vitamin C- Protection against infections

(ii) Vitamin K- Prevention of excessive bleeding

24. Light reaction – Granum/ Grana

Dark reaction – Stroma

25.

Bean plant – class dicotyledonae

Reason

- Two cotyledons in the seed
- Net work veined leaves and are broad
- Tap root system
- Experience secondary growth

Bat- Class mammalian

Reasons

- Has mammary glands
- Body covered with fur
- Gives birth to its young

26.

(a) Enhance non- disjunction resulting to polyploidy

(b) It is used as a meat tenderizer

27. Anaerobes are introduced into a septic tank and they breakdown the human refuse anaerobically

28. (a) Budding

(b)

- Protandry – stamens mature earlier and shed their pollen grains before the stigma matures to receive them.
- Protogyny- Stigma matures earlier before the stamens ripen to release the pollen grains.

29.

- Create aquatic environment for growth of the foetus
- Offer mechanical protection of the foetus from external pressure

30. (a) Pelvic girdle

- (b) (i) Femur
- (ii) Obturator foramen

BIOLOGY PAPER 2

1. (a) F - Oestrogen
 G - Progesterone
- (b) F - Enhance healing of uterine wall after menstruation
 G - Increasing supply of blood to the endometrium/ uterine wall.
- (c) (i) Lutenising hormone
 (ii) Release of the ovum from the ovary, ovulation
 Reorganization of the remains of Graafian follicle into corpus
 Luteum

2. (a) - Male or 1st parent Rr
 - Female or 2nd parent rr

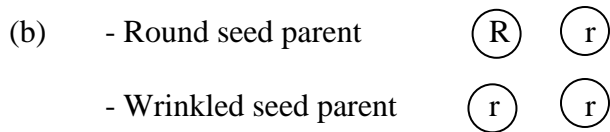

- (c) Parents male/1st X Female/2nd

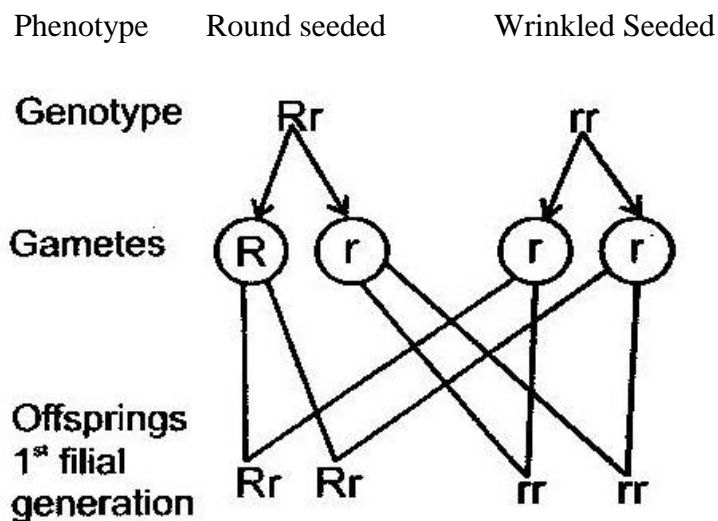

- Genotype 2 – heterozygous round seeded plants
2 – Homozygous wrinkled seeded plants
 - Phenotype 2 – Round seeded plants
2 – Wrinkled seeded plants
- (d) It is the crossing of an organism with the recessive trait in order to determine the genotype of the organism

3. (a) Photosynthesis

(b)

- Presence of sunlight
- Presence of chlorophyll

(c)

- Oxygen gas diffuses to spongy mesophyll cells and used in respiration to produce energy.
- Excess oxygen gas diffuses into the atmosphere through the stomata.
- Glucose is stored in parts of the plant as starch
- Glucose is converted into starch for temporary storage then converted into sucrose for translocation to other parts of the plant
- Glucose is broken down in the process of respiration to produce energy.

4. (a) (i)

- To expose the leaves for maximum absorption of sunlight hence maximizing photosynthesis
- To expose the flowers to enhance pollination hence fertilization.

- To enhance parts of the plant to withstand forces of the environment e.g. air current

(ii)

- To give the body its posture and shape
- Enhance the movement of the animal by the articulation of bones and muscles
- Offering of mechanical protection of delicate organs by the skeleton

(b)

- To avoid predation
- In search of food, mate and shelter
- To colonize new areas
- To move away from unfavourable conditions e.g. foods, fires and earthquakes

5. (a)

- L₁ the piece was placed in a hypotonic solution. The cells absorbed water by Osmosis and became turgid. However the epidermis is water proof and the cells could not absorb water. The piece therefore bulged/ swelled outward on the cut part.
- L₂ the piece was placed in a hypertonic solution. The cells lost water to the surrounding by osmosis and became flaccid. However the epidermis is waterproof and the cells did not lose water. The piece therefore shrunk on the part not affecting the epidermis.

- (b) Maintaining the osmotic pressure helps to maintain the turgidity of plant cells hence supporting the plant.

6. (a) Graph

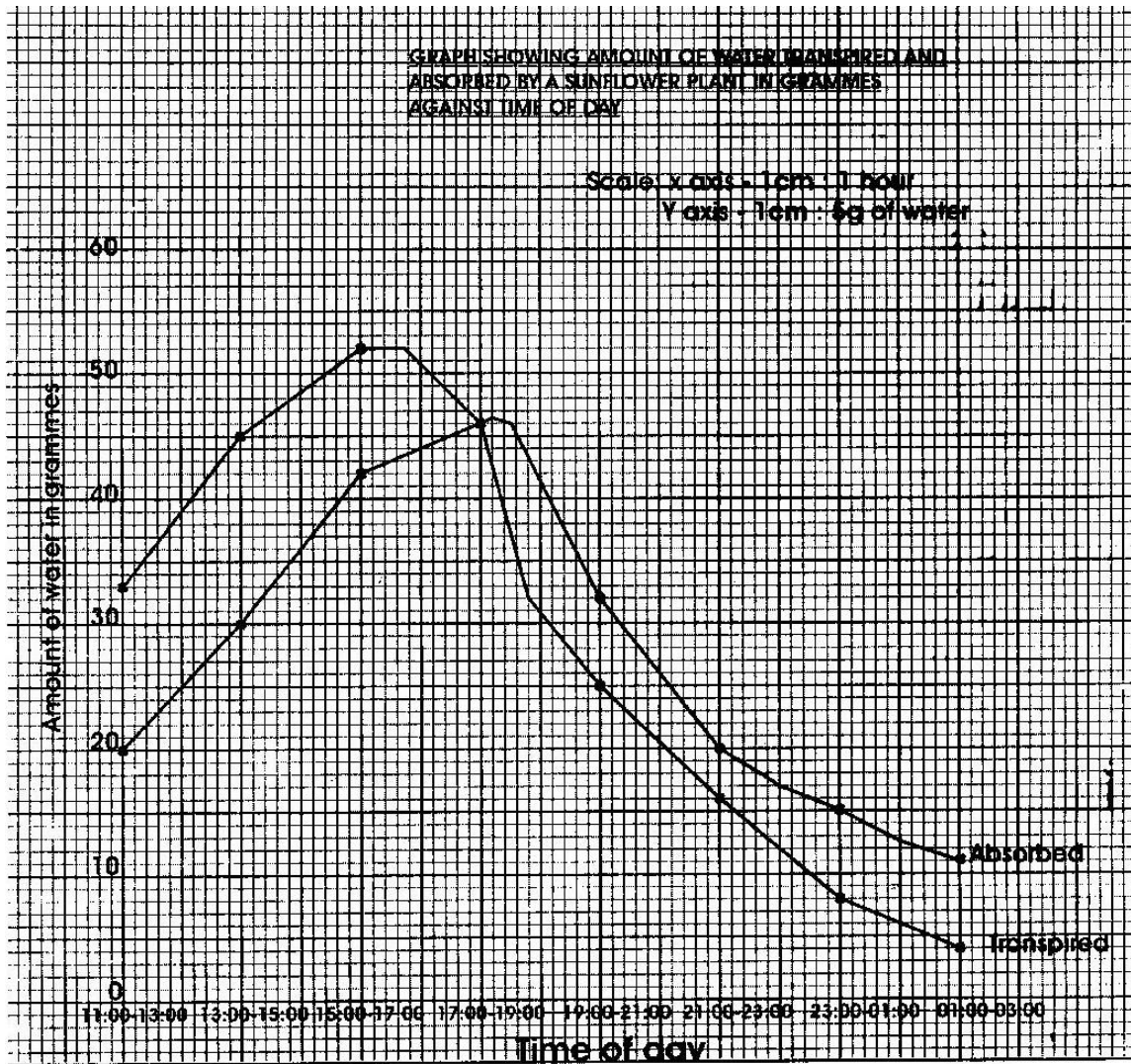

(b) Between 17: 00 and 19.00

(c) (i) **Transpiration**

- Between 11: 00 to 17: 00 the rate of transpiration increased.
- Between these hours, the light intensity, temperature and air currents also increase. These conditions favour high rate of transpiration.
- Between 17:00 to 03:00 the rate of transpiration decreases steadily. The temperatures and light intensity decrease as night falls. Therefore conditions favouring transpiration are absent hence decrease in transpiration.

(ii) **Absorption**

- Between 11:00 to 19:00 the absorption of water increases steadily.
Between these hours conditions favouring transpiration are present hence high loss of water from the plant.
- A suction force is created and more water is absorbed.
- Between 19:00 to 00:300 the absorption of water decreases steadily.
Between these hours the rate of transpiration is decreasing and more water is retained in the plant.
- Less water is absorbed

(d) Both transpiration and absorption would be lower. At 05:00 the temperatures are very low and there is no light. Hence there is very little loss of water.

(e)

- Temperature

- Light intensity
- Air currents
- Atmospheric pressure
- Humidity

(f)

- **Temperature**- As temperature increases the rate of evaporation also increases. More water is lost from the surface of the leaf hence increasing rate of transpiration. As temperature decreases less water evaporates from the surface of the leaf hence decreasing rate of transpiration.
- **Light intensity** – As light intensity increases, it enhances opening of stomata. More water therefore is lost in form of water vapour.
As light intensity decreases (1 dim or dark) the stomata close and little or no water is lost from the leaf hence lower rate of transpiration.
- **Air currents** – Strong air currents drives away the diffuse water vapour from the surface of the leaf creating high diffusion gradient. This increases rate of transpiration. Calm condition allows water vapour to accumulate on the surface of the leaf reducing the diffusion gradient hence lower rate of transpiration.
- **Humidity**- when the amount of water vapour in the air is high, there is low diffusion gradient and less water is lost. When the air is dry, there is high diffusion gradient and more water is lost, hence high rate transpiration.

7.

- It is the cycling of nitrogen compounds in nature. Free nitrogen of the air cannot be used by the plants but has to be converted into ammonium compounds and nitrates in order to be absorbed. It is done by the following ways:
 - Fixation by lightning and thunderstorms
 - The atmospheric oxygen and nitrogen combine and nitric and nitrous acids are formed. They combine with minerals in the soil forming nitrates that are then absorbed
 - Fixation by nitrogen- Fixing bacteria
 - The bacteria can be symbiotic that live in root nodules of leguminous plants e.g. Rhizobium
 - They absorb the nitrogen and convert it into nitrates that are then used by the plant.
 - Other bacteria are free living in the soil e.g. Azotobacter. They absorb the nitrogen and then absorbed by the plants
 - Nitrifying bacteria e.g Nitrosomonas and Nitrococcus
 - When plants and animals die they decompose releasing the proteins in form of ammonium compounds. The nitrifying bacteria oxidize the ammonium compounds into nitrates then to nitrates. They are then absorbed by plants.
 - This process is referred to as ammonification.

- However there some bacteria in the cycle that convert the nitrates to nitrites, ammonia and nitrogen gas that cannot be used by the plant. They are known as the denitrifying bacteria. They reduce the nitrates to obtain the oxygen for their respiration e.g. psocoudomonas denitrificans.

8. (a)

- They are moist to dissolve the diffusing gases
- They are highly folded to increase surface area over which gaseous exchange takes place.
- They are thin walled to reduce distance over which diffusion of gases takes place.
- They are well supplied with blood capillaries to carry the diffusing gases hence creating high diffusion gradient.

(b)

- Gaseous exchange takes place in the alveolus
- The inhaled air has high concentration of oxygen compared to that of blood capillaries. The oxygen first dissolves in the moisture on the surface of the alveolus. It then diffuses across the alveolar wall then through the capillary wall into the red blood cells.
- The hemoglobin in the red blood cells combines with the oxygen forming oxy- hemoglobin.
- The blood is said to be oxygenated and is transported to the heart via the pulmonary vein.

- The carbon (IV) oxide is more concentrated in the blood capillaries than in the alveolar cavity.
- It therefore diffuses across the capillary wall and then through the alveolar wall into the alveolar spaces.
- It is then expelled during exhalation.

PAPER 3 (PRACTICAL)

1. (a) A - liver
B - Stomach
C - Pancreas
D - Ileum
G - Duodenum

- (b) E - Caecum/ appendix – has enzyme cellulase that digests cellulose into maltose.
F - Rectum- absorption of water and being of faecus before being released through the anus.

(c) On the diagram

- (d) (i) Male
(ii) Presence of prostate gland

(e) (i) Magnification = $\frac{\text{Length of drawing}}{\text{Actual length}}$

Magnification = $\frac{9 \text{ cm}}{15 \text{ cm}}$

$$\text{Magnification} = X \ 0.6$$

$$(ii) \ \text{Magnification} = \frac{\text{Length of drawing}}{\text{Actual length}}$$

$$X \ 0.6 = \frac{14.5 \text{ cm}}{X}$$

$$X = \frac{14.5}{0.6}$$

$$\text{Actual length} = 24.17 \text{ cm}$$

2.

Substance	Food substance being tested for	Procedure	Observations	Conclusion
S	Protein	Place a portion of S in a test tube. Add an equal portion of sodium Hydroxide. Shake well. Add a few drops of copper (II) sulphate solution.	Colour turns to purple/ violet	Proteins present
T	Protein	Place a portion of T in a test tube. Add equal portion of sodium hydroxide. Shake well. Add a few drops of copper (II) sulphate solution	Colour turns to pale purple/ pink	Traces of proteins present
U	Protein	Place a portion of U in a test tube. Add an equal portion of sodium hydroxide solution. Shake well. Add a few drops of copper(II) sulphate solution	Colour remains yellow/ orange	Proteins absent

3.

Specimen	Mode of dispersal	Adaptive features
K	Animal dispersal	Hooks have developed on the calyx for attachment to fur or clothes of passing animal.
L	Animal dispersal	Brightly coloured and edible pericarp. Seed coats tough and not digested.
M	Wind dispersal	Seeds have hairy and feather- like projections to increase surfaces so that they are blown by the wind
N	Animal dispersal	Succulent mesocarp and tough indigestible endocarp. Seed not destroyed.
Q	Explosive mechanism	Dry pod with structure/ line of weakness that breaks releasing seeds

- (b) (i) On the diagram
(ii) Free central placentation

(c) Endocarp

WORKED OUT PAST KCSE PRACTICAL QUESTIONS

Example 1

1. You are provided with a specimen labeled K and solution labeled P and Q. Cut the specimen into two halves. From one half remove the outer and an inner leaf of the specimen. Examine them.

K- Onion bulb

P- Distilled water

Q- Saturated sodium chloride solution

- (a) State the observable features of the outer and inner leaves of the specimen.

Answer

Outer leaf

- Thin/ membranous papery (1 mark)
- Scaly/ dry/ dehydrated (1 mark)
- Pigmented / coloured/ brown/ purple/ red (1 mark)

Inner leaf

- Fleshy /succulent/ juicy (1 mark)
- Thick swollen (1 mark)
- White/ cream yellow/ purple/ red/ green (1 mark)

- (b) State the functions of the inner and outer leaves of the specimen

(4 marks)

Answer

Outer leaf- protection (1) protection against transpiration/ drying/ evaporation/

loss of water/ injection/ desiccation/ mechanical damage/ injury

(1) Inner leaf - storage (1); storage of food / water

(c) (i) - Name the type of reproduction exhibited by specimen K.

(1 mark)

- Asexual / vegetative propagation/ vegetative reproduction/
natural vegetative reproduction.

(ii) Give a reason for your answer in c (i) above. (1 mark)

Answer

- Presence of bud(s)

Using the outer half of specimen K, remove some of the inner leaves. Cut the leaves along their lengths into nine strips. Each strip should be about 2 mm wide. Place three strips into the solution labeled P. Place another three strips into the solution labeled Q and leave the last three strips in a Petri dish labeled R. Allow the experimental set ups to stand for 10 minutes.

(d) Use your finger to feel the texture of the strips

Record your observations (2 marks)

Strip in solution P

Answer

Firm/turgid/hard/stiff

Strips in solution AQ

Answer

Soft/ flabby/ flaccid/ flexible/ tender/ limp

- (e) Account for the texture of the strip in solution Q. (4 marks)

Answer

- Q is more concentrated / hypertonic than the cell sap.
- Cells lost water by osmosis
- Hence the cells become flabby/ flaccid/ plasmolysed / shrank

- (f) Suggest the concentration of solution P in relation to the cell sap in the strips of the specimen.

Answer

P is dilute/ less concentrated/ hypotonic

Give a reason for your answer (1 mark)

Answer

Strips remain firm/ turgid/ hard/ stiff/ remain the same/ absorbs some water/ did not become flaccid

- (g) State the aim in the set up R (1 mark)

Answer

Control experiment

Example 2

2. You are provided with a specimen labeled W which was grown in the dark examine the specimen

W- Young Maize seedlings

- (a) Draw and label all the observable parts of the specimen (5 marks)

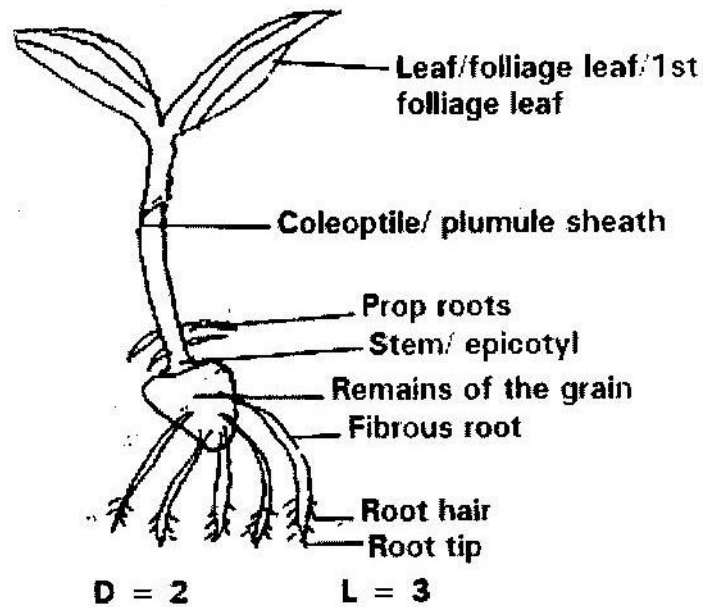

Note:

- Roots (fibrous root) should be single or double lines
- Roots should average from remains
- 2 foliage leaves must be shown
- Outline must be correct.

(b) State the function of any three parts you have labeled (3 marks)

Name of the part	Function
(i) Leaf	- For photosynthesis/ manufacture of food/ gaseous
(ii) Coleoptile/plumule sheath	- Protect the 1 st foliage leaf
(iii) Remains of grain	- Stores food for the young germinating seedling
(iv) Fibrous roots	- Anchoring the seedling to the ground / support.
(v) Root roots	- Transport or conduction of water
(vi) Prop roots	- Absorption of water and minerals salts from the soil.
(vii) Testa	- For anchorage / support
(vii) Root tip	- Protection against desiccation/ damage
(ix) Stem	- Region of cell division/ growth - Supports other parts of plant/ helps in conduction of water.

(c) Cut off the shoot and keep the rest of the specimen to be used in question.

Crush the shoot on a white tile using a glass rod. Carry out the following food tests. Record your observations and conclusion in the table below.

(4 marks)

Test	Observation	Conclusion
(i) Add a drop of iodine solution to a portion of the crushed shoot on the white tile	Colour of iodine remains/ no colour change/ remain yellow/ brown/ red/ orange	Starch absent
(ii) Place another portion of the crushed shoot in a	Turn yellow/ orange/ brown / red	Reducing sugar present

test tube. Add 1 cm ³ of Benedict's solution. Shake the mixture and heat.	Greenish - yellow	Traces of reducing sugar
--	-------------------	--------------------------

(d) Remove the grain from the remaining part of the specimen. Crush it and carry out the following tests. Record your observations and conclusions in the table below.

Test	Observation	Conclusion
(i) Add a drop of iodine solution to a portion of the crushed shoot on the white tile	Blue black/ Blue/ black	Starch present
(ii) Place another portion of the crushed shoot in a test tube. Add 1 cm ³ of Benedict's solution. Shake the mixture and heat.	Colour changes from blue to yellowish green, orange/ brown/ brick red/ red	Simple sugar/ reducing sugar present glucose present

(e) Account for your results in (c) and (d) above (7 marks)

Answer

- The grain stores starch during germination. Some of the starch in the grain is converted/ broken down/ hydrolysed by enzyme/ amylase/diastase to reducing/simple sugars. The sugars are translocated/ moved to the shoot. The shoot did not photosynthesize.